



4. Hatch & Portlight



As the global leader in the production of sail and powerboat hatches, Lewmar offers an extensive range of solutions, producing over 200,000 hatches and portlights a year. Whether your requirement is a sleek opening port or a robust offshore access hatch, Lewmar has the solution.

Modern trends have led to larger openings and more customized shapes which naturally allow designers to create a signature look and feel to their products.

4. Hatch & Portlight

CE Regulations

The CE Regulations apply to craft up to 24m in length that are sold in the European Union. Although the Regulations may not apply to your boat, they are a useful guide for small craft throughout the world.

- The Regulations have Design Categories for boats based on their intended usage and propulsion (sail or power). Boats built to CE Regulations are fitted with a plate showing the Design Category.
- All Lewmar hatches and portlights are for Design Category A (Ocean Sailing) or Design Category B (Offshore Sailing).
- The Regulations divide up the hull and deck into four specific 'areas'. These are shown below.

- For craft with a freeboard greater than 1/12 of its overall length, the hull is split into Area 1 and Area 2B. Please refer to the Recreational Craft Directive 94/25/EC.
- A product that is suitable for fitting to an area for which it is approved is suitable for all the areas below its category. For example, a portlight that is approved for Area 2A may also be fitted to Areas 3 and 4, but not Areas 1 or 2B.
- All the hatches and portlights in this publication are CE Approved for the areas indicated on the product pages.
- Lewmar warranties are invalid if the product is installed in an area where it is not intended, and if the installation fails to meet the requirements of the CE Regulations.

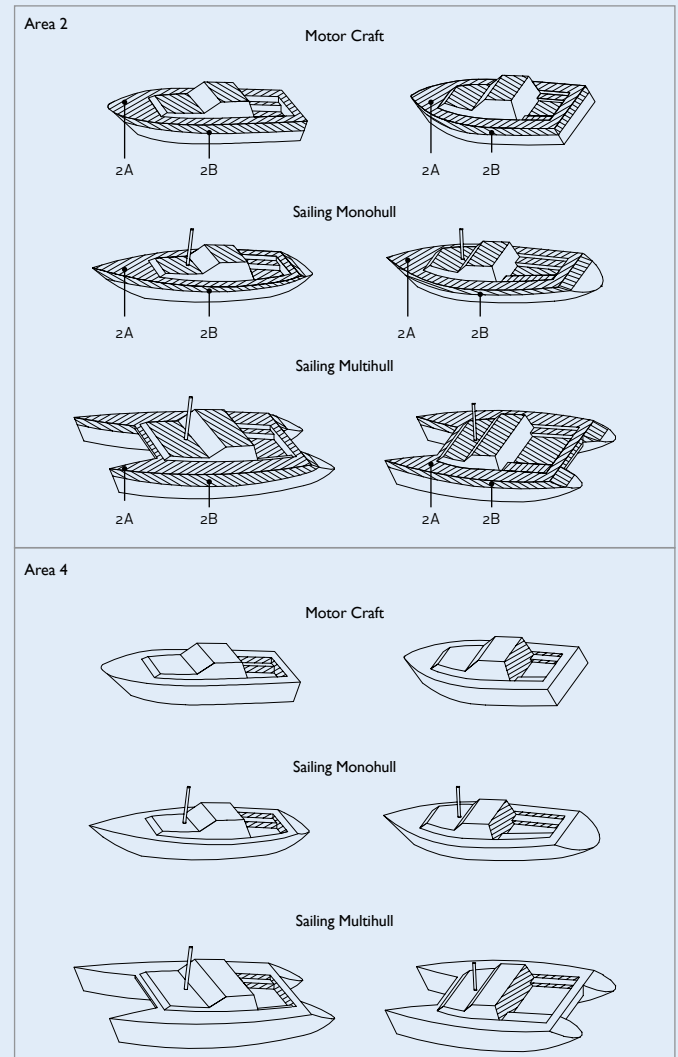
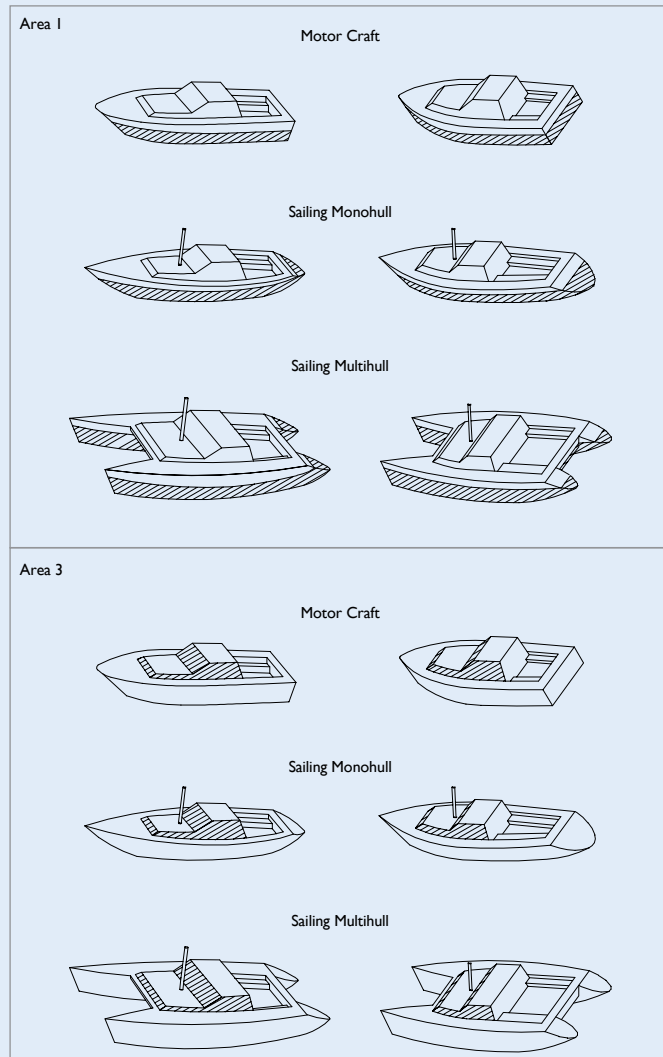

Hatches

DESCRIPTION	SIZES	CATEGORY	AREA
LOW PROFILE	ALL	A	2A, 3 & 4
MEDIUM PROFILE	ALL	A	2A, 3 & 4
OCEAN HATCH	ALL	A	2A, 3 & 4
FLUSH HATCH	ALL	A	2A, 3 & 4
PILOT HATCH	ALL	A	3 & 4

Portlights

DESCRIPTION	SIZES	CATEGORY	AREA	DESCRIPTION	SIZES	CATEGORY	AREA
STANDARD	ALL	A	2A, 3 & 4	STAINLESS	0,1,1RE,7RE,8	B	1, 2, 3 & 4
ATLANTIC	10, 30, 32	A	1, 2, 3 & 4	STAINLESS	ROUND	A	1, 2, 3 & 4
ATLANTIC	40, 60	A	2A, 3 & 4	FLUSH MITRE	0, 1, 3 & 4	A	2A, 2B, 3 & 4
STAINLESS	0,1,1RE,7RE,8	A	2A, 3 & 4				

The Lewmar Hatch Range

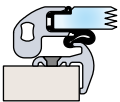
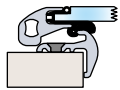
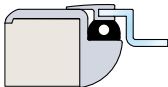
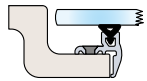

Flush Hatches

Page 134 Flush Hatch 2G

- Sleek, modern look
- Fits seamlessly into a specially designed recess in the deck
- Seal mounted on the acrylic
- Acrylic has band of paint to conceal deck & frame when installed
- Custom configuration available including stainless steel hinge, handle and stay.

Page 136 Flush Hatch 3G

- All the benefits of the flush hatch
- Lower frame mounted seal
- All external fittings flush to the acrylic

Page 140 Custom Flush Hatches

- Stainless Flush Hatch 2G
- Horizon Hatch - Acrylic curved to match deck camber
- GRP Frame Hatch - Bonded directly onto the deck

Framed Hatches

Page 143 Ultra-Low Profile Hatch

- 6mm above-deck height
- Easy to retrofit for flush aesthetic

Page 133 Low Profile Hatch

- Soft styling and sleek looks
- Does not require deck recess to install
- Available in Round and D-Hatch configuration

Page 146 Medium Profile Hatch

- Ideal as a foredeck hatch on larger offshore yachts
- Provides greater strength and durability
- Thicker acrylic and deeper frame sections
- Medium Profile styled to match Low Profile for mixed deck specifications

Page 148 Ocean Hatch

- Ultimate protection against the elements
- Classical styling and rugged construction
- Fitted to thousands of boats throughout the world
- 2 profiles available with or without flange

Page 150 Custom Hatches

- Stainless Hatch
- Integral Privacy Blind
- Flybridge Hatch
- Pilot Hatch
- Powerboat Hatch
- Washboard Hatch
- Companionway Door
- Crew Door

Page 161 Hatch Spares and Accessories

- Flyscreens
- Hinge spares
- Spare acrylics
- Hatch Identification Guide

4. Hatch & Portlight



Flush Hatch 2G

Lewmar pioneered the production flush hatch platform back in 2006, bringing superyacht styling into volume boat production. The precision of the fit makes for a sleek, modern look and means no more stubbed toes for boat owners.

- Clean aesthetics
- EPDM seal provide completely watertight structure
- Water drained effortlessly away by deck-moulded channels
- Strong, stylish handles and hinges
- Trimkit fit all standard sizes
- Dark grey acrylic option keeps cabin cooler
- Custom sizes available
- Available with stainless steel hatch furniture
- Full range of spare parts available on-line www.lewmar.com



Flush Hatch Standard Sizes



Size 10

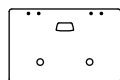

Size 20

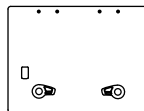

Size 30

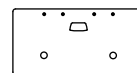

Size 41

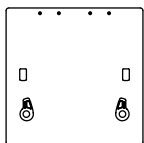

Size 44*

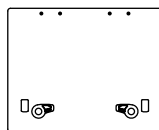

Size 54*

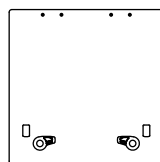

Size 60

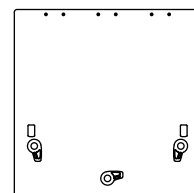

Size 70



* Minimum size for ISO 9094 escape hatches.



Flush Hatch 2G Standard Specifications

- White lower frame
- Black exterior moulding
- Grey Interior moulding
- Acrylic colours: Grey or Dark Grey
- Size 20 and 41 supplied with friction lever
- Other sizes use 1 or 2 stays
- Hatches should be fitted to a flat surface with a maximum tolerance of +/-1mm
- Cutout dimensions changes if a trim is used: Add 4mm to X1 & Y1 and 2mm to R1.
- Fastening size: for lower frame section use 5mm CSK screws No. 10 UNC 2BA
- Fastening size: at the hinge section use M6 (1/4")

Flush Hatch Dimensions

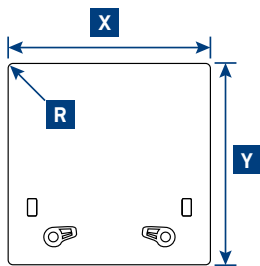

Flush Hatch Cut-outs

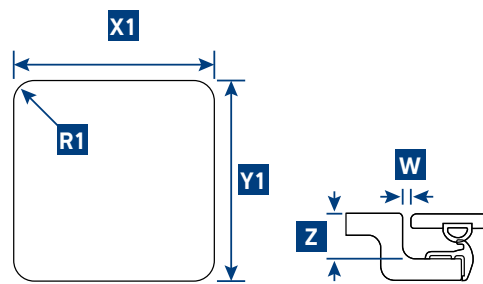

PART NO GREY ACRYLIC	PART NO DARK GREY ACRYLIC	SIZE	W LOWER FRAME FLANGE		W HINGE GAP		OVERALL DIMENSIONS						CUT-OUT DIMENSIONS						ACRYLIC WINDOW THICKNESS		WEIGHT			
			MM	IN	MM	IN	X WIDTH		Y LENGTH		Z DEPTH		R RADII		X1 WIDTH		Y1 LENGTH		R1 RADII		MM	IN	KG	LB
39910012	39910812	10	15	9/16	11	11/64	330	13	330	13	31	1 1/4	10	3/8	260	10 1/4	260	10 1/4	42.5	1 11/16	12	1/2	2.3	5
39920012	39920812	20	15	9/16	11	11/64	417	16 7/16	272	10 11/16	31	1 1/4	10	3/8	347	13 11/16	202	7 15/16	42.5	1 11/16	12	1/2	2.4	5.3
39930012	39930812	30	15	9/16	11	11/64	527	20 3/4	397	15 5/8	31	1 1/4	10	3/8	457	18	327	12 7/8	42.5	1 11/16	12	1/2	4.7	10.3
39941012	39941812	41	15	9/16	11	11/64	491	19 5/16	246	9 1/16	31	1 1/4	10	3/8	421	16 9/16	176	6 15/16	42.5	1 11/16	12	1/2	2.6	5.8
39944012	39944812	44	15	9/16	11	11/64	512	20 3/16	512	20 3/16	31	1 1/4	10	3/8	442	17 3/8	442	17 3/8	42.5	1 11/16	12	1/2	5.4	12
39954012	39954812	54	15	9/16	11	11/64	577	22 11/16	462	18 3/16	31	1 1/4	10	3/8	507	19 15/16	392	15 7/16	42.5	1 11/16	12	1/2	5.5	12.1
39960012	39960812	60	15	9/16	11	11/64	577	22 11/16	577	22 11/16	31	1 1/4	10	3/8	507	19 15/16	507	19 15/16	42.5	1 11/16	15	9/16	7.1	16
39970012	39970812	70	15	9/16	11	11/64	697	27 1/2	697	27 1/2	31	1 1/4	10	3/8	627	24 11/16	627	24 11/16	42.5	1 11/16	15	9/16	11	24

4. Hatch & Portlight



Flush Hatch 3G

With improved manufacturing techniques, the Flush Hatch 3G continues to push the envelope of hatch design and has quickly become a staple design element in many new yachts. A tough, tinted acrylic panel is all that can be seen on deck.

- Lower frame mounted seal
- Strengthened, extruded aluminium frame hidden discreetly below deck
- Completely flush fittings
- Exterior handle available for foredeck use
- Interchangeable with Flush Hatch 2G
- Built in locking mechanism



Flush 3G Hatch Standard Sizes

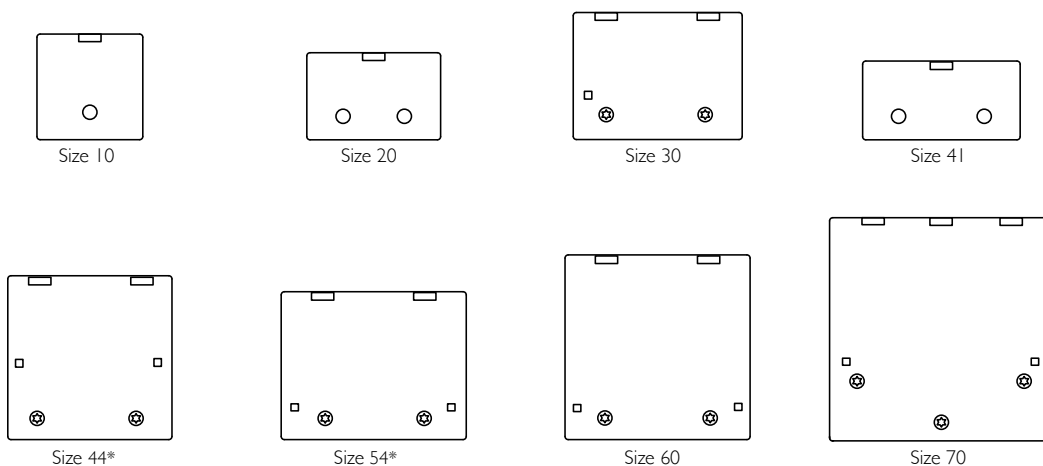

* Minimum size for ISO 9094 escape hatches.
Hatch must have external handle option for use in ISO 9094

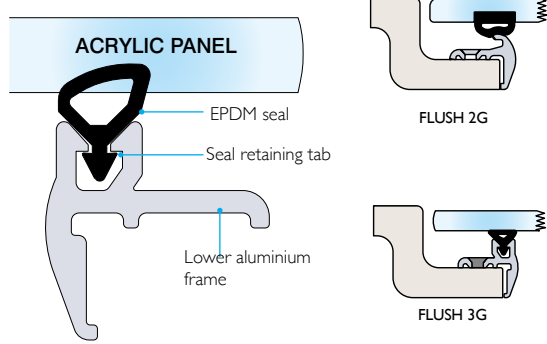

Flush Hatch 3G Standard Specifications

- White lower frame
- Black mouldings
- Acrylic colours grey or dark grey
- Size 10, 20 and 41 supplied with friction hinges and plain flush exterior handle caps.
- Size 30, 44, 54, 60 and 70 supplied with 1 or 2 stays and winch handle opening handles

Flush Hatch 3G Dimensions

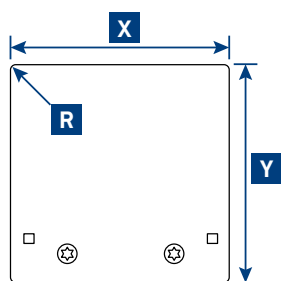

Flush Hatch 3G Cut-outs

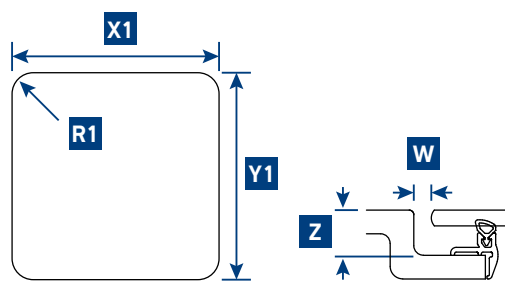

PART NO GREY ACRYLIC	PART NO DARK GREY ACRYLIC	SIZE	W LOWER FRAME FLANGE		W HINGE GAP		OVERALL DIMENSIONS								CUT-OUT DIMENSIONS						ACRYLIC WINDOW THICKNESS		WEIGHT	
			MM	IN	MM	IN	X WIDTH		Y LENGTH		Z DEPTH		R RADI		X1 WIDTH		Y1 LENGTH		R1 RADI		MM	IN	KG	LB
399104996	399104924	10	15	9/16	11	11/64	330	13	330	13	31	1 1/4	10	3/8	260	10 1/4	260	10 1/4	42.5	1 11/16	10	3/8	2.1	4.6
399204996	399204924	20	15	9/16	11	11/64	417	16 7/16	272	10 11/16	31	1 1/4	10	3/8	347	13 11/16	202	7 15/16	42.5	1 11/16	10	3/8	2.2	4.8
399304995	399304923	30	15	9/16	11	11/64	527	20 3/4	397	15 5/8	31	1 1/4	10	3/8	457	18	327	12 7/8	42.5	1 11/16	10	3/8	3.9	8.6
399414996	399414924	41	15	9/16	11	11/64	491	19 5/16	246	9 1/16	31	1 1/4	10	3/8	421	16 9/16	176	6 15/16	42.5	1 11/16	10	3/8	2.3	5.0
399444995	399444923	44	15	9/16	11	11/64	512	20 3/16	512	20 3/16	31	1 1/4	10	3/8	442	17 3/8	442	17 3/8	42.5	1 11/16	10	3/8	4.5	9.9
399544995	399544923	54	15	9/16	11	11/64	577	22 11/16	462	18 3/16	31	1 1/4	10	3/8	507	19 15/16	392	15 7/16	42.5	1 11/16	10	3/8	4.6	10.1
399604995	399604923	60	15	9/16	11	11/64	577	22 11/16	577	22 11/16	31	1 1/4	10	3/8	507	19 15/16	507	19 15/16	42.5	1 11/16	12	1/2	6.2	13.7
399704995	399704923	70	15	9/16	11	11/64	697	27 1/2	697	27 1/2	31	1 1/4	10	3/8	627	24 11/16	627	24 11/16	42.5	1 11/16	12	1/2	9.0	19.8

PLEASE NOTE WINCH HANDLE OPENING DOES NOT MEET THE REQUIREMENTS OF DESIGNATED FIRE EXITS IN THE DRAFT FOR THE NEW VERSION OF ISO9094

4. Hatch & Portlight



Flush Hatch 2G with Stainless Steel furniture

At Lewmar, we are constantly seeking to improve our product range to suit evolving design trends. The new range of stainless steel hatch fittings are designed for the Flush Hatch Range, offering a stylish interior and exterior aesthetic.

- Hatch can be opened from the outside using a standard winch handle
- Locking mechanism contained in interior handle
- Effortless operation
- Closer fit to the deck along the hinge edge
- All the features of the Flush Hatch Range
- White aluminium lower frame
- Stainless Steel handles, hinges and stay
- Grey or Dark Grey Acrylic



PART NO GREY ACRYLIC	PART NO DARK GREY ACRYLIC	SIZE	LOWER FRAME FLANGE		OVERALL DIMENSIONS								CUT-OUT DIMENSIONS						ACRYLIC WINDOW THICKNESS	
			MM	IN	X WIDTH		Y LENGTH		Z DEPTH		R RADII		X1 WIDTH		Y1 LENGTH		R1 RADII			
					MM	IN	MM	IN	MM	IN	MM	IN	MM	IN	MM	IN	MM	IN		
399441999	399441910	44	15	9/16	512	20 3/16	512	20 3/16	31	1 1/4	10	3/8	442	17 3/8	442	17 3/8	42.5	1 11/16	12	1/2
399601999	399601910	60	15	9/16	577	22 11/16	577	22 11/16	31	1 1/4	10	3/8	507	19 15/16	507	19 15/16	42.5	1 11/16	15	9/16
399701999	399701910	70	15	9/16	697	27 1/2	697	27 1/2	31	1 1/4	10	3/8	627	24 11/16	627	24 11/16	42.5	1 11/16	15	9/16

PLEASE NOTE WINCH HANDLE OPENING DOES NOT MEET THE REQUIREMENTS OF DESIGNATED FIRE EXITS IN THE DRAFT FOR THE NEW VERSION OF ISO9094



Custom Sized Flush Hatches

Lewmar manufacture custom size hatches in high volume for many boat builders. The table below list the most common sizes. Please note that trimkits are not available on custom size hatches.

Standard Specifications

- Silver lower frame
- Grey exterior moulding
- Grey Interior moulding
- Grey Acrylic

White Specifications

- White lower frame
- Black exterior moulding
- Grey Interior moulding
- Grey Acrylic

PART NUMBER	SPECIFICATION	W LOWER FRAME FLANGE		W HINGE GAP		OVERALL DIMENSIONS						CUT-OUT DIMENSIONS						ACRYLIC WINDOW THICKNESS			
		MM	IN	MM	IN	X WIDTH		Y LENGTH		Z DEPTH		R RADII		X1 WIDTH		Y1 LENGTH		R1 RADII		MM	IN
30190400	STANDARD	15	9/16	11	11/64	575	22 5/8	284	11 3/16	31	1 1/4	10	3/8	505	19 7/8	214	8 7/16	42.5	1 11/16	12	1/2
30190500	STANDARD	15	9/16	11	11/64	575	22 5/8	551	21 11/16	31	1 1/4	10	3/8	505	19 7/8	481	18 15/16	42.5	1 11/16	12	1/2
30190600	STANDARD	15	9/16	11	11/64	575	22 5/8	773	30 7/16	31	1 1/4	10	3/8	505	19 7/8	703	27 11/16	42.5	1 11/16	12	1/2
30195400	STANDARD	15	9/16	11	11/64	330	13	329	12 15/16	31	1 1/4	10	3/8	260	10 1/4	259	10 3/16	42.5	1 11/16	12	1/2
30193500	WHITE	15	9/16	11	11/64	210	8 1/4	400	15 3/4	31	1 1/4	10	3/8	140	5 1/2	330	13	42.5	1 11/16	12	1/2

Custom Flush Hatch Design Options

Custom Radius Corners

As a further styling aid, Lewmar can manufacture flush hatches with custom radii on the corners.



Alloy Lid

Lewmar can supply flush hatches with a plain aluminium panel in place of the acrylic. Teak, or other deck finishes, can then be applied over the top and appropriate handles fitted.



Bent Flush

Lewmar has the capability to bend the framework and acrylic panel to match coachroof curvatures.



White Acrylic

Opaque white acrylic can be specified. This is particularly useful on heads' ventilation hatches, deck lockers or where privacy is a prime concern.



Chamfered Acrylic Edges

The edges of flush hatch acrylics can be chamfered. This achieves a flush look when the deck recess cannot be made to exact specification.



4. Hatch & Portlight



Horizon Hatch

The Horizon Hatch has a lid that is curved to match the camber of the deck. This results in a cleaner aesthetic, especially on sailing boat decks where it is often more difficult to use a conventional flat hatch. Innovative design ensures that sealing and watertight integrity are not compromised.

Horizon Hatches are customised to individual yacht designs. Please contact your Lewmar representative at an early stage in the design process to discuss your requirements.

- Machined and polished acrylic to match cambered decks
- Acrylic mounted seal
- Strong, flat aluminium frame
- Completely flush exterior fittings
- Exterior handle available for foredeck use
- Built-in locking mechanism

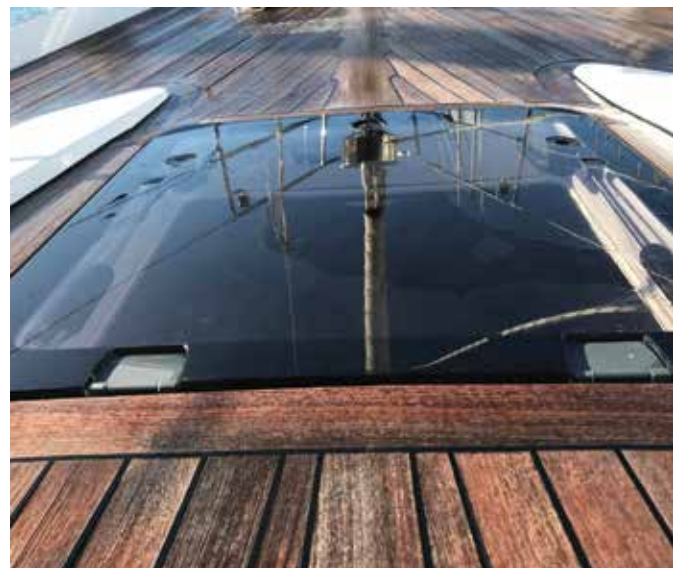



GRP Frame Hatch

Lewmar's premium flush composite hatch offers a flexible solution with sizing to match OEM requirements, providing an ultimate flush finish from the outside and sleek smooth finish from the inside.

The frame is bonded into the deck structure during the boat building process.

- Fitted with stainless steel handles and gas-strut supports
- Concealed heavy duty stainless steel hinges for a durable sturdy hatch that closes flush while allowing the acrylic to have sharper angles allowing a tighter fit with the deck aperture
- Lower frame made of GRP (glass-reinforced plastic) can be bonded into the boat to achieve a fully flush effect
- Lower frame configured to accept customer's preferred drainage positions
- Acrylic, Cambered acrylic or Glass lid options available.



PART NUMBER	SIZE
399355900	35
399605900	60
399705900	70

4. Hatch & Portlight



Ultra-Low Profile Hatch

Following trends towards flush, clean lines, Lewmar have developed a robust, elegant, ultra-slim hatch to minimise impact on deck aesthetics while following the design principles of the proven low profile system.

Conceived as a product for boat builders and owners, the Ultra-low Profile Hatch can be incorporated into new designs with ease while also offering a retrofit solution in current Lewmar installations. As the perfect blend of utility and elegance, the design uses multiple seal profiles to guarantee compression and excellent water-shedding capability.

The Ultra-low Profile Hatch is a revolutionary approach to framed hatch design, supplying strength, beauty and safety.

- Available in industry-standard Lewmar sizes
- Re-styled hinges provide an elegant internal aspect
- Seal profiles are designed to deflect water away from the aperture
- Gas struts ensure easy opening and securing
- Above-deck height of only 6mm





Low Profile Hatch

The Low Profile Hatch has soft styling and sleek looks, ideal for use on a powerboat. Smaller ventilation hatches are suitable for any deck location on sailboats, while the larger sizes can be used as foredeck hatches on smaller to mid size yachts.

- Outside handles allow the hatch to be opened from on deck if it is not locked
- Low profile hatches open up to 180° (round hatches open to 170°)
- Friction levers hold the lid open in any position up to 95°
- Anodised aluminium frame for corrosion resistance
- Curved upper frame profile for strength as well as modern styling
- Available in Round and D-Hatch configuration, with grey or white acrylic
- Full range of spare parts available on-line www.lewmar.com

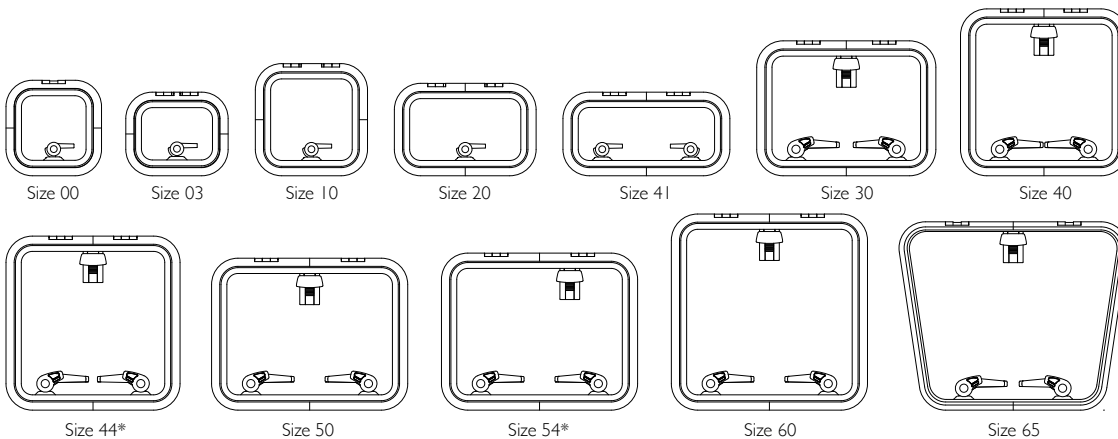

* Minimum size for ISO 9094 escape hatches

4. Hatch & Portlight

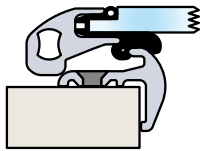

Low Profile Hatch Standard Specifications

- Grey mouldings
- Acrylic colours grey, clear or white
- Size 30 - 65 supplied with friction hinges as standard
- Simple and easy maintenance on parts

Low Profile Hatch Dimensions

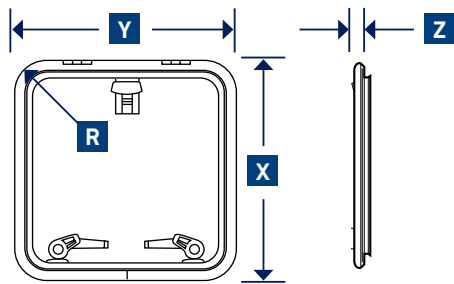

Low Profile Hatch Cut-outs

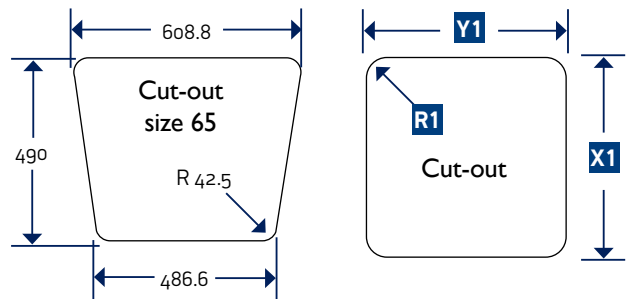

PART NUMBER FRICTION LEVER LID	PART NUMBER HATCH WITH STAY	SIZE	LOWER FRAME FLANGE		OVERALL DIMENSIONS										CUT-OUT DIMENSIONS CHANGE IF TRIMKITS ARE USED						HATCH WEIGHT		ACRYLIC WINDOW THICKNESS	
					X		Y		Z		R		X1		Y1		R1							
					MM	IN	MM	IN	MM	IN	MM	IN	MM	IN	MM	IN	MM	IN	MM	IN				
39900030		00	15	9/16	281	11 1/16	281	11 1/16	25	1	72.5	2 7/8	211	8 5/16	211	8 5/16	42.5	1 11/16	1.6	3.5	8	5/16		
39903030		03	15	9/16	246	9 11/16	301	11 7/8	25	1	72.5	2 7/8	176	6 15/16	231	9 1/8	42.5	1 11/16	1.6	3.5	8	5/16		
39910030	399100303	10	15	9/16	330	13	330	13	25	1	72.5	2 7/8	260	10 1/4	260	10 1/4	42.5	1 11/16	2.2	4.9	8	5/16		
39920030		20	15	9/16	272	10 11/16	417	16 7/16	25	1	72.5	2 7/8	202	7 15/16	347	13 11/16	42.5	1 11/16	2.3	5.1	8	5/16		
39930030	399300303	30	15	9/16	397	15 5/8	527	20 3/4	25	1	72.5	2 7/8	327	12 7/8	457	18	42.5	1 11/16	4.2	9.3	8	5/16		
39940030	399400303	40	15	9/16	491	19 5/16	491	19 5/16	25	1	72.5	2 7/8	421	16 9/16	421	16 9/16	42.5	1 11/16	4.6	10.1	8	5/16		
39941030		41	15	9/16	246	9 11/16	491	19 5/16	25	1	72.5	2 7/8	176	6 15/16	421	16 9/16	42.5	1 11/16	2.5	5.5	8	5/16		
39944030	399440303	44	15	9/16	512	20 3/16	512	20 3/16	25	1	72.5	2 7/8	442	17 3/8	442	17 3/8	42.5	1 11/16	4.8	10.6	8	5/16		
39950030	399500303	50	15	9/16	447	17 5/8	577	22 11/16	25	1	72.5	2 7/8	377	14 13/16	507	19 15/16	42.5	1 11/16	4.8	10.6	8	5/16		
39954030	399540303	54	15	9/16	462	18 3/16	577	22 11/16	25	1	72.5	2 7/8	392	15 7/16	507	19 15/16	42.5	1 11/16	4.9	10.8	8	5/16		
39960030	399600303	60	15	9/16	577	22 11/16	577	22 11/16	25	1	72.5	2 7/8	507	19 15/16	507	19 15/16	42.5	1 11/16	6.4	14.1	10	3/8		
39965030		65	15	9/16	560	22 11/16	560 MIN 675 MAX	22 11/16 26 9/16	25	1	72.5	2 7/8	SEE DRAWING ABOVE				42.5	1 11/16	6.5	14.3	10	3/8		



Low Profile Round Hatch Dimensions & Cut-out

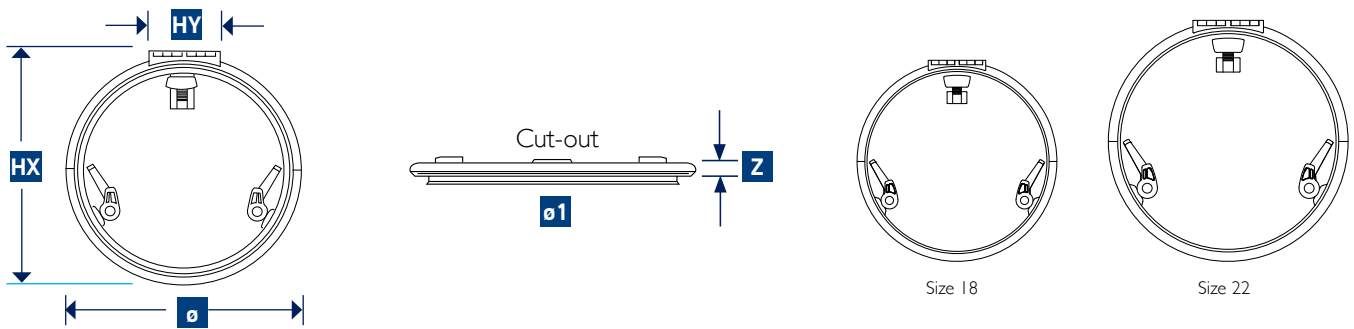

PART NUMBER	SIZE	LOWER FRAME FLANGE		OVERALL DIMENSIONS						CUT-OUT DIMENSIONS Change if Trimkits are used				HATCH WEIGHT		ACRYLIC WINDOW THICKNESS	
		MM	IN	DIAMETER Ø		HEIGHT Z		HINGE LENGTH HX		HINGE WIDTH HY		DIAMETER Ø1		KG	LB	MM	IN
				MM	IN	MM	IN	MM	IN	MM	IN	MM	IN				
39918030	18	15	9/16	490	19 15/16	25	1	493	19 7/16	141	5 9/16	420	16 9/16	3.8	8.4	8	5/16
39922030	22	15	9/16	588	23 1/8	25	1	591	23 1/4	173	6 13/16	518	20 3/8	5.8	12.8	10	3/8

Low Profile D-Hatch Dimensions & Cut-out

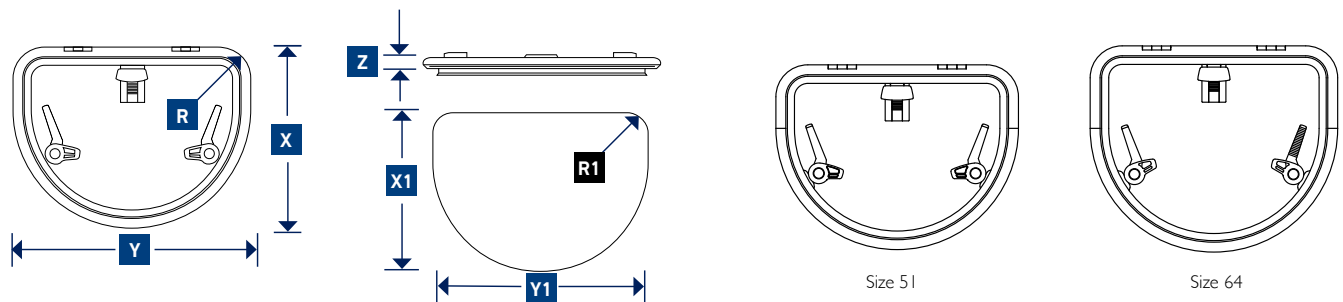

PART NUMBER	SIZE	LOWER FRAME FLANGE		OVERALL DIMENSIONS						CUT-OUT DIMENSIONS Change if Trimkits are used						HATCH WEIGHT		ACRYLIC WINDOW THICKNESS			
		MM	IN	LENGTH X		WIDTH Y		HEIGHT Z		RADI R		LENGTH X1		WIDTH Y1		RADI R1		KG	LB	MM	IN
				MM	IN	MM	IN	MM	IN	MM	IN	MM	IN	MM	IN	MM	IN				
39951030	51	15	9/16	448	17 5/8	588	23 1/8	25	1	72.5	2 7/8	378	14 7/8	518	20 3/8	42.5	1 11/16	5.5	12.1	8	5/16
30067300	64	15	9/16	500	19 11/16	600	23 5/8	25	1	72.5	2 7/8	430	16 15/16	530	20 7/8	42.5	1 11/16	6.4	14.1	8	5/16

4. Hatch & Portlight



Medium Profile Hatch

Ideal as a foredeck hatch on larger offshore yachts, the Medium Profile has thicker acrylic and deeper frame sections for greater strength and durability. It features Lewmar's unique sealing system, allowing for easy acrylic replacement. The Medium Profile Hatch blends ruggedness with the smooth, modern lines of the Low Profile Hatch.

- Outside handles allow the hatch to be opened from on deck if it is not locked
- Friction levers hold the lid open in any position up to 95°
- Anodised aluminium frame for corrosion resistance
- Curved upper frame profile for strength as well as modern styling
- Full range of spare parts available on-line www.lewmar.com

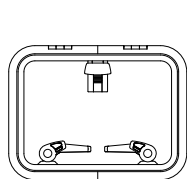

Size 30

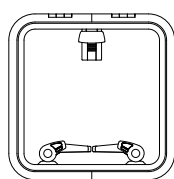

Size 40

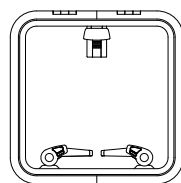

Size 44*

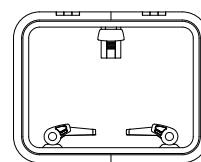

Size 50

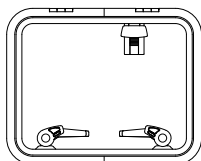

Size 54*

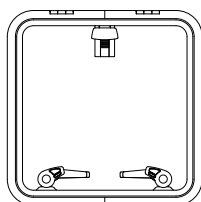

Size 60

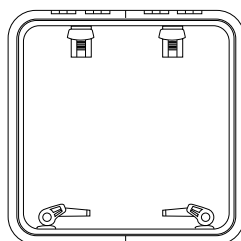

Size 70

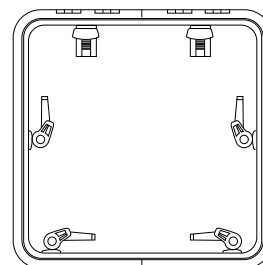

Size 77



* Minimum size for ISO 9094 escape hatches

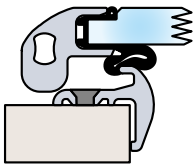

Medium Profile Hatch Standard Specifications

- Grey mouldings
- Acrylic colours grey, clear or white
- Size 30 - 65 supplied with friction hinges as standard
- Simple and easy maintenance

Medium Profile Hatch Dimensions

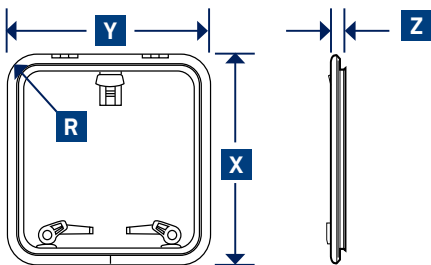

Medium Profile Hatch Cut-out

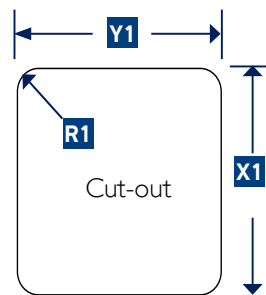

PART NUMBER	SIZE	LOWER FRAME FLANGE		OVERALL DIMENSIONS							CUT-OUT DIMENSIONS CHANGE IF TRIMKITS ARE USED						HATCH WEIGHT		ACRYLIC WINDOW THICKNESS		
		MM	IN	X LENGTH		Y WIDTH		Z HEIGHT		R RADI		X1 LENGTH		Y1 WIDTH		R1 RADI		KG	LB	MM	IN
39930020	30	15	9/16	398	15 5/8	528	20 3/4	32	1 1/4	78	3 1/16	327	12 7/8	457	18	42.5	1 11/16	5	11.1	12	1/2
39940020	40	15	9/16	492	19 3/8	492	19 3/8	32	1 1/4	78	3 1/16	421	16 9/16	421	16 9/16	42.5	1 11/16	5.9	13	12	1/2
39944020	44	15	9/16	513	20 3/16	513	20 3/16	32	1 1/4	78	3 1/16	442	17 3/8	442	17 3/8	42.5	1 11/16	6.4	14.1	12	1/2
39950020	50	15	9/16	448	17 5/8	578	22 3/4	32	1 1/4	78	3 1/16	377	14 13/16	507	19 15/16	42.5	1 11/16	6.3	13.9	12	1/2
39954020	54	15	9/16	463	18 1/4	578	22 3/4	32	1 1/4	78	3 1/16	392	15 7/16	507	19 15/16	42.5	1 11/16	6.5	14.3	12	1/2
39960020	60	15	9/16	578	22 3/4	578	22 3/4	32	1 1/4	78	3 1/16	507	19 15/16	507	19 15/16	42.5	1 11/16	7.8	17.2	12	1/2
39970020	70	15	9/16	698	27 1/2	698	27 1/2	32	1 1/4	78	3 1/16	627	24 11/16	627	24 11/16	42.5	1 11/16	10.6	23.4	12	1/2
39977020	77	15	9/16	770	30 5/16	770	30 5/16	32	1 1/4	78	3 1/16	699	27 1/2	699	27 1/2	42.5	1 11/16	12.7	28	12	1/2

4. Hatch & Portlight



Ocean Hatch

With its classic style, the Ocean Hatch is fitted to many offshore cruising boats around the world. Its rugged construction provides the ultimate protection against the elements, whatever conditions you might face. Available with flat base or flange base.

- Friction levers hold the lid open in any position up to 95°
- Anodised aluminium frame for corrosion resistance
- Full range of spare parts available on-line www.lewmar.com

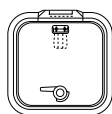

Size 10

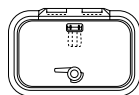

Size 20

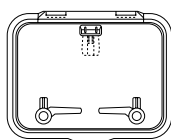

Size 30

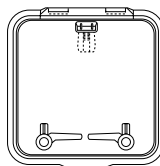

Size 40

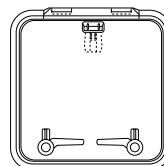

Size 44*

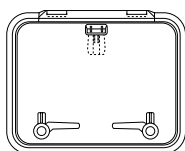

Size 50

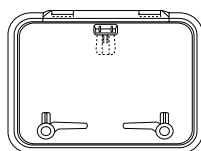

Size 54

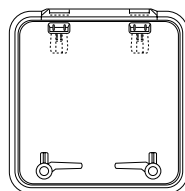

Size 60

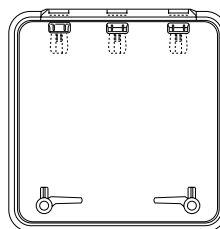

Size 70



Approved

ALL SIZES
AREA 2A.
SEE PAGE 132

* Minimum size for ISO
9094 escape hatches

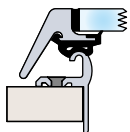

Flange profile

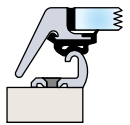

Flat Base profile

Ocean Hatch Standard Specifications

- Grey mouldings
- Acrylic colour: grey
- Size 30 - 65 supplied with friction hinges as standard
- Simple and easy maintenance

Ocean Hatch Dimensions

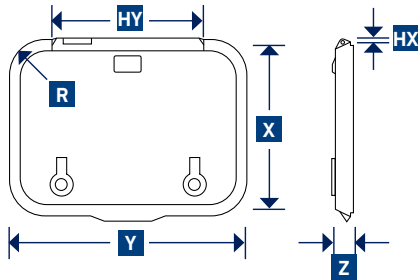

Ocean Hatch Cut-out

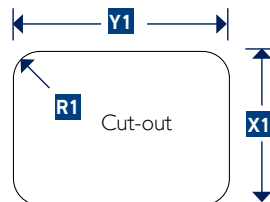

PART NUMBER	SIZE	LOWER FRAME	OVERALL DIMENSIONS										CUT-OUT DIMENSIONS Change if Trimkits are used						HATCH WEIGHT		ACRYLIC WINDOW THICKNESS			
			X LENGTH		Y WIDTH		Z HEIGHT		R RADI	HX HINGE LENGTH		HY HINGE WIDTH		X1 LENGTH		Y1 WIDTH		R1 RADI						
			MM	IN	MM	IN	MM	IN	MM	IN	MM	IN	MM	IN	MM	IN	MM	IN	MM	IN	KG	LB	MM	IN
39610050	10	FLAT BASE FLANGE	324	12 3/4	324	12 3/4	39.5	1 9/16	75	2 15/16	5	3/16	138	5 7/16	255	10 1/16	255	10 1/16	40	1 9/16	2.26	5.77	10	3/8
39610070		FLAT BASE FLANGE													260	10 1/4	260	10 1/4	42.5	1 11/16				
39620050	20	FLAT BASE FLANGE	266	10 1/2	411	16 3/16	39.5	1 9/16	69	2 11/16	5	3/16	225	8 7/8	197	7 3/4	342	13 7/16	34	1 5/16	2.74	6.04	10	3/8
39620070		FLAT BASE FLANGE													202	7 15/16	347	13 11/16	36.5	1 7/16				
39630050	30	FLAT BASE FLANGE	391	15 3/8	521	20 1/2	39.5	1 9/16	75	2 15/16	5	3/16	335	13 3/16	322	12 11/16	452	17 13/16	40	1 9/16	4.5	9.9	10	3/8
39630070		FLAT BASE FLANGE													327	12 7/8	457	18	42.5	1 11/16				
39640050	40	FLAT BASE FLANGE	485	19 1/8	485	19 1/8	39.5	1 9/16	75	2 15/16	5	3/16	299	11 3/4	416	16 3/8	416	16 3/8	40	1 9/16	4.76	10.5	10	3/8
39640070		FLAT BASE FLANGE													421	16 9/16	421	16 9/16	42.5	1 11/16				
39644050	44	FLAT BASE FLANGE	509	20 1/16	509	20 1/16	43	1 11/16	76	3	4	3/16	302	11 7/8	437	17 3/16	437	17 3/16	40	1 9/16	5	11	12	1/2
39644070		FLAT BASE FLANGE													442	17 3/8	442	17 3/8	42.5	1 11/16				
39650050	50	FLAT BASE FLANGE	444	17 1/2	574	22 5/8	43	1 11/16	76	3	4	3/16	367	14 7/16	372	14 5/8	502	19 3/4	40	1 9/16	7.3	16.1	12	1/2
39650070		FLAT BASE FLANGE													377	14 13/16	507	19 15/16	42.5	1 11/16				
39654050	54	FLAT BASE FLANGE	459	18 1/16	574	22 5/8	43	1 11/16	76	3	4	3/16	367	14 7/16	387	15 1/4	502	19 3/4	40	1 9/16	7.6	16.7	12	1/2
39654070		FLAT BASE FLANGE													392	15 7/16	507	19 15/16	42.5	1 11/16				
39660050	60	FLAT BASE FLANGE	574	22 5/8	574	22 5/8	43	1 11/16	76	3	4	3/16	367	14 7/16	502	19 3/4	502	19 3/4	40	1 9/16	8	17.6	12	1/2
39660070		FLAT BASE FLANGE													507	19 15/16	507	19 15/16	42.5	1 11/16				
39670050	70	FLAT BASE FLANGE	694	27 5/16	694	27 5/16	43	1 11/16	76	3	4	3/16	487	19 3/16	622	24 1/2	622	24 1/2	40	1 9/16	10.8	23.8	12	1/2
39670070		FLAT BASE FLANGE													627	24 11/16	627	24 11/16	42.5	1 11/16				

4. Hatch & Portlight



Stainless Steel Hatch

Using Lewmar's proven hatch technology, Lewmar are now able to offer stainless steel deck hatches. The stainless hatch complements and matches other stainless fittings on a high specification deck.

The hatches have a similar profile to the highly successful Medium Profile Hatch and are directly interchangeable. This flexibility allows boat builders to tailor deck specification to individual customer requirements without retooling.

- High-polished stainless steel upper frame and hinges
- High-polished stainless or black fittings
- CE approved Area 2A
- Gas struts available as an option
- White lower frame



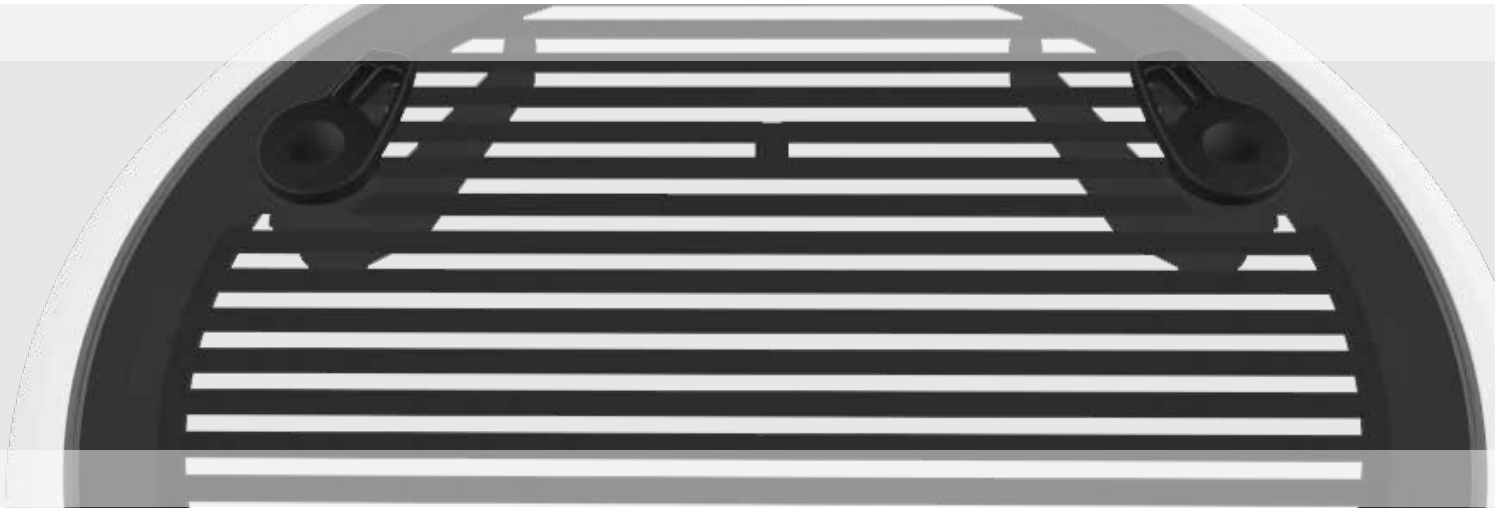

Integral Privacy Blind

The Lewmar Integral Privacy Blind provides a low-cost blind solution.

The blind is permanently installed under the hatch lens. When the shutter is open a pattern of stripes across the lens provides a moderate level of privacy. When the slider is operated, the lens is completely obscured to ensure that no one can see into the cabin. This system is ideal for cabins and heads compartments where there is no room to fit a Roller Shade.

The Integral Privacy Blind can be specified on any Lewmar hatch to suit an OEM's specific requirements.

- Clean aesthetics
- Simple operation with effective blackout



4. Hatch & Portlight



Pilot Hatch

The Pilot Hatch is designed for use on the wheelhouse or cockpit canopy of a power craft, and the styling complements the Low Profile and Medium Profile Hatch Ranges.

- Opens up enclosed steering positions
- Sliding technology from Lewmar's hardware track systems, ensuring minimum friction
- The Pilot Hatch uses Lewmar's unique seal system for improved sealing and easy servicing
- Operated with a single handlebar that rotates to seal down the hatch
- Can be secured with a 5cm opening when full ventilation is not required



Pilot Hatch Dimensions

Cut-out Dimensions

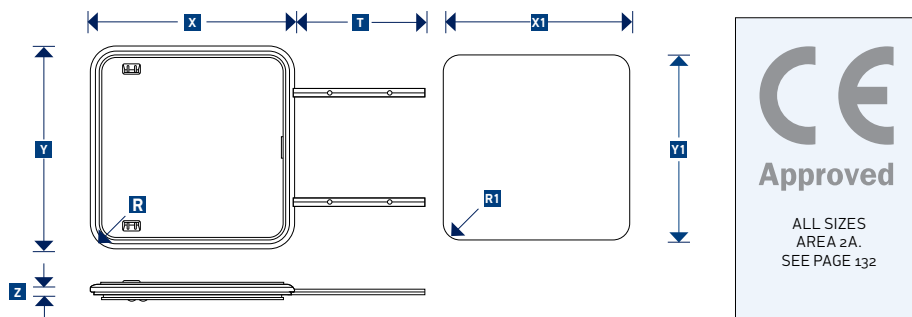

PART NUMBER	SIZE	ACRYLIC COLOUR/TINT	LOWER FRAME FLANGE		OVERALL DIMENSIONS								CUT-OUT DIMENSIONS Change if Trimkits are used						ACRYLIC WINDOW THICKNESS			
					X WIDTH		Y LENGTH		Z HEIGHT		R RADII		T TRACK LENGTH		X1 WIDTH		Y1 LENGTH				R1 RADII	
					MM	IN	MM	IN	MM	IN	MM	IN	MM	IN	MM	IN	MM	IN			MM	IN
30211300	40	SMOKE GREY	15	9/16	495	19 1/2	491	19 5/16	29	1 1/8	73	2 7/8	284	11 3/16	421	16 9/16	421	16 9/16	42.5	1 11/16	8	5/16
30074000	60	SMOKE GREY	15	9/16	581	22 7/8	577	22 11/16	29	1 1/8	73	2 7/8	373	14 2/3	507	19 15/16	507	19 15/16	42.5	1 11/16	10	3/8
30229100	70	SMOKE GREY	15	9/16	701	27 5/8	697	27 7/16	29	1 1/8	73	2 7/8	486	19 1/8	627	24 11/16	627	24 11/16	42.5	1 11/16	10	3/8
30069900	78	SMOKE GREY	15	9/16	844	33 1/4	790	31 1/8	29	1 1/8	73	2 7/8	638	25 1/8	770	30 5/16	720	28 1/4	42.5	1 11/16	10	3/8

Trim Kits are not available for size 78, normal Trim Kit fits size 40, 60 and 70.

Hatches should be fitted to a flat surface with a maximum tolerance of ± 1 mm.

The Pilot Hatch is only for use on wheel houses and cockpit canopies. It is not suitable for use on normal decks and coachroof applications. Fastening size for lower frame and sliding track use 5mm CSK screws No. 10 UNC 2BA

The pilot hatch cannot be operated from the outside.



Powered Pilot Hatch

Following market demands for more sophisticated systems, Lewmar have used their considerable design experience to create an innovative powered pilot hatch for simple ventilation control.

Effortless operation is achieved through a range of switching options. The full mechanism and railings are contained within the aperture of the hatch and the above-deck profile is only 35mm, ensuring the visual impact is minimal.

Lewmar have developed a truly premium product, blending effortless utility with stunning design.

- Compact mechanism utilises spiral cables for smooth operation
- Load sensing closure provides protection from entrapment
- Can be retrofitted to same aperture as the standard pilot hatch
- Can be held in any position to allow varying degrees of ventilation
- Available in Grey or Dark Grey acrylic
- Frame finishes include Matte clear anodized, Bright clear anodized, Black powder coat, White powder coat
- Custom sizes available on request
- 12V or 24V Options available



BASE PART NUMBER	SIZE	ACRYLIC COLOUR/TINT	UPPER/LOWER FRAME FINISH	POWER 12/24V	OVERALL DIMENSIONS												CUT-OUT DIMENSIONS Change if Trimkits are used						ACRYLIC WINDOW THICKNESS	
					LOWER FRAME FLANGE		X WIDTH		Y LENGTH		Z HEIGHT		R RADII		T TRACK LENGTH		X1 WIDTH		Y1 LENGTH		R1 RADII			
					MM	IN	MM	IN	MM	IN	MM	IN	MM	IN	MM	IN	MM	IN	MM	IN	MM	IN		
30320600	60	CONTACT YOUR LEWMAR REPRESENTATIVE			45	1 3/4	581	22 7/8	577	22 11/16	29	1 1/8	73	2 7/8	373	14 2/3	510	20	510	20	42.5	1 2/3	10	3/8
30307400	70				45	1 3/4	701	27 5/8	697	27 7/16	29	1 1/8	73	2 7/8	486	19 1/8	630	24 3/4	630	24 3/4	42.5	1 2/3	10	3/8
30307500	78				45	1 3/4	844	33 1/4	790	31 1/8	29	1 1/8	73	2 7/8	638	25 1/8	773	30 7/16	723	28 1/2	42.5	1 2/3	10	3/8

4. Hatch & Portlight



Flybridge Hatch

Lewmar's flybridge hatches offer a safe and attractive way of accessing to the helm station on flybridge vessels.

Lewmar can customise the shape and size to match OEM requirements. They can be built around the low profile, medium profile or flush hatch platforms.

As with other products acrylic colour, frame finish, lid-support mechanisms etc can be customised to suit.

Contact your Lewmar representative for further information.

- Elegant access point to different levels
- Available in range of finishes: powder-coated aluminium, stainless steel or frameless
- Powered option offers hands-free operation
- Radius or Mitre corners available



The flybridge hatches are intended for use between two wet areas. Therefore ISO 12216 certification is not required.



Powered Hatches

In response to shifting design priorities, Lewmar has designed a powered hatch platform for a range of installation possibilities.

Powered hatches are ideal for areas that are difficult to reach by hand, or for hatches too heavy for easy manual operation. Activated at the touch of a button, the smooth opening action is powered by durable, marinised actuators. Internal sensors prevent over-opening and ensure uncompromised seal compression.

Contact your Lewmar representative to discuss our bespoke design process.

- Clean aesthetics based on our proven hatch platforms
- Durable components
- Available in a range of finishes and sizes, custom specified
- Smooth and stable operation

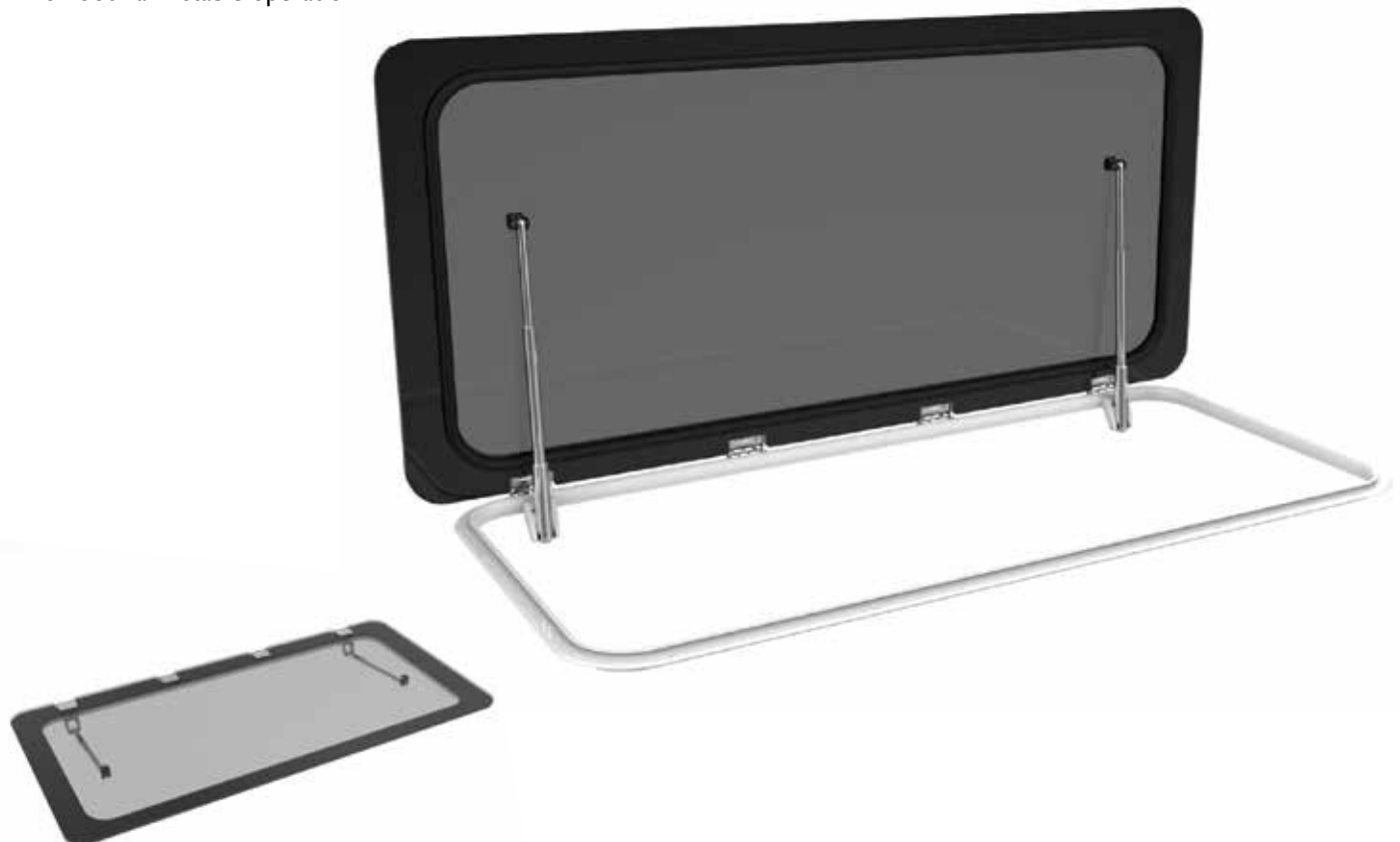

4. Hatch & Portlight



Powerboat Hatch

The Lewmar power boat hatch is a premium product; customisable to suit individual tastes and finished to the highest standards.

316 stainless fittings and polished bevelled edges exude quality and the painted acrylic hides the seal, framework and deck fixings from view.

- Clean aesthetics
- EPDM seal and gas struts provide high-quality operation
- A range of exterior styling options available
- Painted acrylic to hide seal, lower frame and fixings
- A selection of handle variations available from plastic to stainless steel
- Highly polished bevelled edge to give a premium finish
- Stainless hinges available
- Flexible length and strength options





Washboard Hatch

Lewmar's washboard hatch offers a complete turnkey solution to boat-builders who have traditionally fabricated their own washboard solutions in-house.

Lewmar's solution is highly flexible; as long as the sides of the companionway are parallel, Lewmar can produce a washboard to suit.

- Lockable from inside and out
- Simple one-handed operation
- Sprung panels
- Choice of 1 or 2 acrylic panels
- Choice of acrylic colour
- Optional air vents
- Comes with hard anodised side runners

Contact your Lewmar representative for more information.



4. Hatch & Portlight



Access Doors

Building on 50 years of hatch design, Lewmar are constantly developing platforms to offer more onboard solutions. The introduction of watertight doors in various applications is a display of our continued commitment to boat management and safety.

Crew Door

Developed as a discreet solution for concealing crew accommodation, the crew door concept provides a robust closure without interrupting sleek transom lines.

- Locking handles ensure high seal compression
- Available with white or stainless furniture
- Integrated privacy shutter allows enhanced crew concealment
- Sturdy aluminium construction powder-coated to customer specification



Companionway Door

Lewmar strive to identify solutions that follow market trends. The companionway door is a powerboat-focussed solution that combines elegance with functionality to generate unmatched attention to customer desires.



- Custom-shaped acrylic to customer specification, encouraging innovative design concepts
- Flexible solution to a host of varying design scenarios
- Based on proven hatch and hardware platforms
- Secure and watertight entry point to saloon



Soft Roofs and Sun Canopies

In recent years solar shading and sliding roof systems have significantly increased in popularity. Utilising proprietary aluminium extrusions Lewmar is able to offer a range of soft roofs and canopies to match the OEMs specific requirements.

Our sliding roofs are built on the backbone of Lewmar's proven hardware range and are available in both manual and powered options. They can be supplied complete with fabric ready for installation or the OEM can fit their own choice of fabric.

Lewmar's folding arm sun canopies are custom-sized to suit the boat's requirements. Available in stainless steel or aluminium and powered for ease of use. As with our sliding roofs, the fabric can be supplied with the roof or can be customer-sourced. Remote control is available as an option.

- **Soft canvas retractable roof**
- **Can be scaled/sized to fit most boats**
- **Manual and motorised version is available**
- **Roof can be locked in various open positions, which are customisable**
- **Main beams have individual tensioning system to ensure canvas is taut over length and width**
- **Canvas locking system allows for easy canvas removal for maintenance**



4. Hatch & Portlight

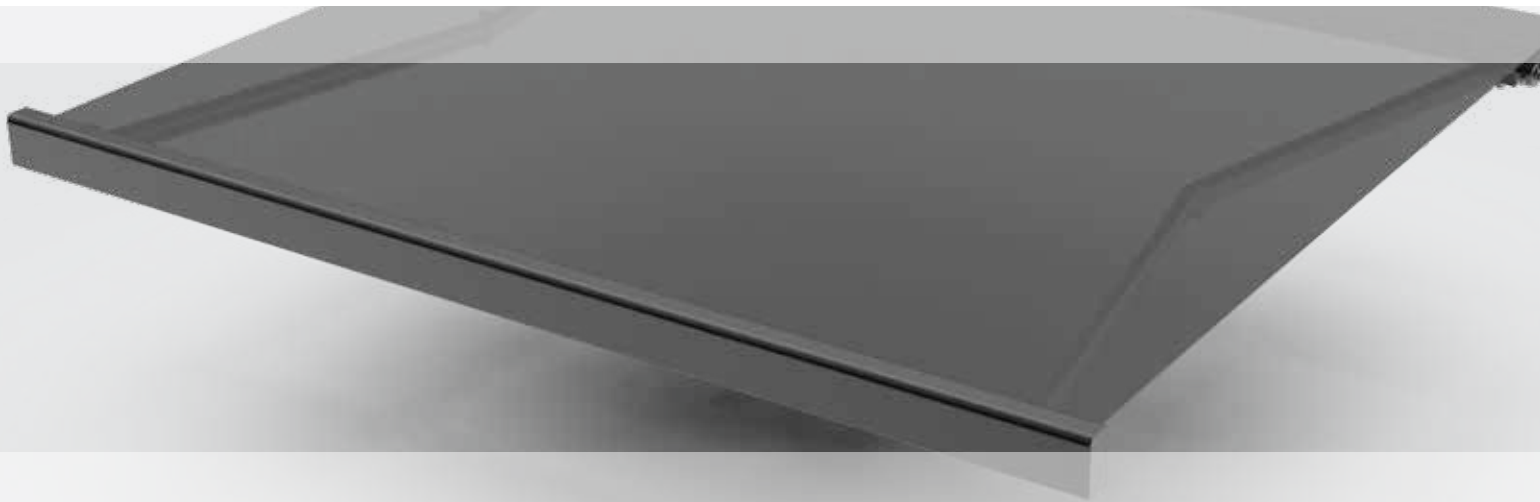

Aft Retracting Sun Canopy

A recent addition to the Lewmar range, the electric retractable canopy offers a sleek sunshade, most commonly used in aft areas while not under way.

Built from stylish oval stainless steel tubing and investment-cast end fittings, the canopy can be deployed via its single electric motor at the touch of a button. Gas springs within the folding arms keep the canopy under constant tension at various stages of deployment.

An aluminium valance is available in a custom range of colours, providing a seamless finish to the superstructure when in the fully stowed position.

- Soft canvas or mesh fabric
- 316 Stainless Construction
- 12V or 24V Power Options
- Simple installation and fabric replacement
- A built-in mechanism allows for height adjustment post installation
- Carbon or Stainless Steel poles for supports whilst underway
- Custom sizes upon request
- Valances can be custom formed to suit superstructure



Hatch Accessories

ABS Plastic Trim and Flyscreen

- Easy and stylish way of finishing a hatch installation inside the cabin
- Trim kits come complete with a flyscreen
- Can only be fitted to boats with a headlining
- Will fit all standard hatches featured in this catalogue except flat base Ocean Hatches or unless otherwise stated

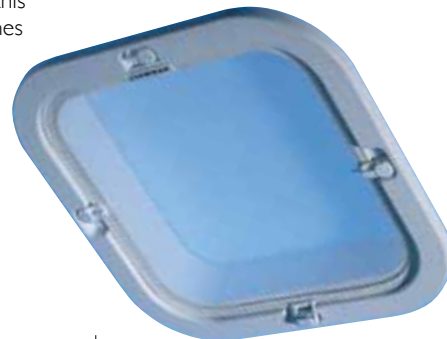

Cut Out Dimensions and Deck Thickness Requirements

CUT OUT DIMENSION INCREASE ¹	ADD 4MM TO X1 @ Y1 AND 2MM TO R1
OCEAN	MIN HULL THICKNESS = 25MM MAX HULL THICKNESS = 72MM
FLUSH HATCH / LOW AND MEDIUM PROFILE	MIN HULL THICKNESS = 15MM MAX HULL THICKNESS = 62MM

¹ Cut Out dimensions for hatches are shown on their relevant pages

PART NUMBER	HATCH SIZE	PART NUMBER	HATCH SIZE	PART NUMBER	HATCH SIZE
367400252	00 ²	367622252	22 ROUND	367651252	51
367403252	03	367630252	30	367654252	54
367410252	10	367640252	40	367660252	60
367618252	18 ROUND	367441252	41	367665252	65
367420252	20 ²	367644252	44	367670252	70
367620252	20 OCEAN	367650252	50		

² Does not fit Ocean, Rollstop or Superhatch

Telescopic Stay

- Features excellent lid positioning and rigid control
- Allows hatch opening up to 95°
- An advantage on smaller to mid size yachts where deck space is at a premium

Grey 360918999 Black: 360918992



Retro-Fit Vent

- Vent can be fitted to the acrylic lens of any Lewmar hatch or to the deck
- Made from the same rugged composite used in many Lewmar hatch and winch parts
- Styled to match the Low and Medium Profile hatches
- Captive bung to close the ventilator – it cannot be lost
- Fits deck thickness to 100mm
- Tested to CE ISO 12216 and leak tested
- No sealant required for hatch fitting

Grey: 361041990 Mini Grey: 361899990
Black: 361041992 Mini Black: 361899991



Retro-Fit Lock and Key Kit

- Can be fitted to any Lewmar Hatch by drilling a hole through the acrylic and riveting a catch block to the lower frame
- Lock and key are marinised to prevent corrosion

Part No 360259990



Flyscreen Hinge

- Makes it easier to access the handles when the flyscreen is in place
- Only necessary to undo two tabs and the flyscreen will hinge down – and not fall out
- Flyscreen can be removed and stowed separately if required
- Hinges are also available as retro fit items
- Kit includes all tabs, screws, screw cap etc.

White: 361196992



4. Hatch & Portlight Hatch Spares

Hinge Caps



PART NO	KIT
361027999	LOW AND MEDIUM PROFILE HINGE CAP X 10
361044999	LOW AND MEDIUM PROFILE HINGE CAP X 100

Catch Block



PART NO	KIT
360924990	LOW AND MEDIUM PROFILE SPARE (GREY)
360924992	LOW AND MEDIUM PROFILE SPARE (BLACK)
360060990	OCEAN CATCH BLOCK SPARE

Straight Joint Inserts



PART NO	KIT
360925999	UPPER FRAME JOINT INSERT (STRAIGHT)

Round Joint Inserts



PART NO	KIT
360926999	UPPER FRAME JOINT INSERT (ROUND)

Handle kits



PART NO	KIT
361680990	LP / MP / OCEAN HANDLE KIT GREY
36168099*	LP / MP / OCEAN HANDLE KIT BLACK
361680992	FLUSH 2G / 3G HANDLE KIT BLACK
36168099*	FLUSH 2G / 3G HANDLE KIT GREY
360255990	SMALL LH HANDLE KIT GREY
360255992	SMALL LH HANDLE KIT BLACK
360256990	SMALL RH HANDLE KIT GREY
360256992	SMALL RH HANDLE KIT BLACK

Outside Handles



PART NO	KIT
360919990	LP / MP EXTERNAL HANDLE GREY X 5
360919992	LP / MP EXTERNAL HANDLE BLACK X 5

LP/MP Hatch Hinge Kit (Friction)

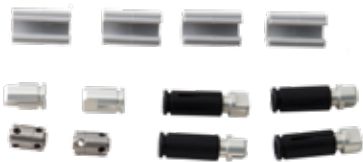

PART NO	KIT
361263999	LP / MP MK2 ALLOY LID HINGE KIT

Friction Lever



PART NO	KIT
360917990	LP / MP GREY F-LEVER SPARE
360271990	OCEAN 00-20 GREY F-LEVER SPARE
360272990	OCEAN 30-40 / CL30-60 F-LEVER SPARE
360273990	OCEAN 50 / CL65+ F-LEVER SPARE

Friction Lever Gaskets



PART NO	KIT
361206999	GASKET - SMALL F-LEVER X 20
361207999	GASKET - LARGE F-LEVER X 20

Low Profile Seal



PART NO	LOW PROFILE HATCH SIZE
360860999	00
360861999	03
360862999	05
360863999	10
360864999	20
360865999	21
360866999	30
360867999	40
360868999	41
360869999	44
360870999	50
360871999	54
360872999	60
360873999	61
360874999	65 (TRAPEZOID)
360875999	18 (ROUND)
360876999	22 (ROUND)

Medium Profile Seal



PART NO	MEDIUM PROFILE HATCH SIZE
360959999	30
360960999	40
360961999	44
360962999	50
360963999	54
360964999	60
360965999	66
360966999	70
360968999	77

Vent Seal

PART NO	DESCRIPTION
361446999	VENT SEALS KIT

Ocean Hatch Seal



PART NO	OCEAN HATCH SIZE
360370999	00
360371999	10
360372999	20
360373999	30
360374999	40
360381999	44
360375999	50
360382999	54
360376999	60
360377999	63
360378999	65
360379999	70
360380999	75
360383999	77

Flush Hatch IG/2G Seal



PART NO	FLUSH HATCH SIZE
361590999	10
361597999	20
361598999	30
361591999	44
361592999	60
361592999	70
361594999	18 (ROUND)
361595999	22 (ROUND)
361596999	27 (ROUND)

Low Profile Acrylic

For Mk2 (post-2000) hatches with friction lever



PART NO	SIZE
361050900	00
361051900	03
361052900	10
361053900	20
361054900	21
361055900	30
361056900	40
361057900	41
361058900	44
361059900	50
361060900	54
361061900	60
361062900	61
361063900	65 (TRAPEZOID)
361064900	18 (ROUND)
361065900	22 (ROUND)

Medium Profile Acrylic

For hatches with friction lever



PART NO	SIZE
361130900	30
361131900	40
361132900	44
361133900	50
361134900	54
361135900	60
361136900	70
361137900	77

Misc. Flush Hatch 3G Spares

PART NO	KIT
360918299	F3G STAY TOP CAP KIT BLACK
361894999	F3G STAY UPPER HINGE KIT

4. Hatch & Portlight

How to identify your Lewmar hatch

Spares are specific to certain ranges of hatch, so identification is essential for ensuring correct parts are used. Hatches produced after October 1997 have information stamped in the acrylic which will identify them - please quote this when ordering spares.

IDENTIFYING FEATURES	SUPERHATCH	ROLLSTOP	TRIMLINE	COASTLINE ® TRANSPORT	OCEAN	CONCEPT	LOW PROFILE	MEDIUM PROFILE
PRODUCTION DATES	1980-87	1986-92	1988-99	1991-99	1991 - NOW	1994-00	1998 -NOW	1999 - NOW
HEIGHT ABOVE DECK (MM)	50	39-42	21	21	40-43	19	25	32
LID IS HELD OPEN BY A STAY		•	EARLY MODELS				RETROFIT OPTION	RETROFIT OPTION
ACRYLIC NOT BONDED INTO AN ALLOY FRAME						•	•	•
AS THE LID IS LIFTED, IT CLICKS THROUGH A SERIES OF POSITIONS AT WHICH THE HATCH WILL HOLD OPEN	•	•						
CATCH BLOCKS IN CORNERS OF THE LOWER FRAME	•							
LARGE INSIDE HANDLES HAVE RED OR GREY LOCKING BUTTONS INSIDE HANDLE		•	•	•	•		•	•
HINGE HAS A BLACK METAL STRAP EXTENDING A SHORT WAY OVER THE ACRYLIC.	•							

Superhatch

- Produced 1980 - 1987.
- Catch blocks in corners of the lower frame
- Spares no longer available



Rollstop

- Produced 1986 - 1992.
- Red locking button in larger handles
- Spares no longer available



Trimline

- Produced 1988-1999
- Red locking button in larger handles
- Fastenings inside lip
- Metal sliding stay
- Seals and handles available as spares.



Coastline

- Produced 1991 - 1999
- Locking button in larger handles
- Fastenings inside lip
- Friction lever
- Seals, friction lever and handles available as spares



Ocean Hatch

- Produces 1991 - now
- Locking button in larger handles
- Inverted "J" profile lower frame
- Friction lever
- High profile lid
- Full range of spares available



Low Profile Hatch

- Produced 1998 - now
- Replaceable acrylic panel
- Small handles bonded on
- Mark 1 and Mark 2
- Quote acrylic marking when ordering spares



Medium Profile Hatch

- Produced 1999 - now
- Replaceable acrylic panel
- Mark 1 and Mark 2



Flush 2G

- Produces 2006 - now
- Painted acrylic lid
- Seal attached to acrylic
- Full range of spares available
- Quote acrylic marking when ordering spares



Flush 3G

- Produced 2010 - now
- Seal attached to lower frame
- Full range of spares available
- Quote acrylic marking when ordering spares



How to find your lens code

All Lewmar hatches and portlights (except old Standard) produced since October 1997 have had identification information stamped on the acrylic. On Portlights and Fixedlights the information is under the LEWMAR branding. On hatches the information is between the right hand handle and the edge of the acrylic.

Identifying the range name & hatch size

For Hatches: Ocean, Coastline, Trimport, Trimline or Concept

For Portlights: Standard (New Standard only), Atlantic, Ocean or ASTAR (Hallberg Rassy only)

There are three different formats:



On some Lewmar hatches you may need to peel back the seal slightly to reveal the code.

The size is abbreviated as **SZXX**, for example :

SZ60 = Size 60 hatch

For portlights the 2 digits used are the 4th and 5th digits of the part number. The 1st digit denotes the size, the 2nd the configuration. For example:

SZ42 = Size 4 New Standard opening portlight

SZ41 = Size 1 New Standard Fixed light

A number in the form **399SSXR**

SS is the hatch size

X is the acrylic colour: 0 - grey, 2 - clear, 3 - white, 4 - green, 6 - frosted, 8 - dark grey

R is the Range: 3 is Low Profile and 2 is Medium Profile

On Mark 2 Low & Medium Profile hatches the number is preceded by 'A'.

A number in the form **300XXX**. This is the first 6 digits of a hatch or portlight custom product part number.

Identifying the date of manufacture

This appears at the end of the code, in the form **DDMY** (for example 11J7) where the letter code for the month is:

A - January

B - February

C - March

D - April

E - May

F - June

G - July

H - August

J - September

K - October

L - November

M - December

The letter I "India" is not used

There are some features that the coding does not identify. For example:

- Frame finish / colour
- Friction Lever or power boat Stay
- If accessories such as Lock & Key Kit and Vent are fitted

This information, and an acrylic code identifier, are available at lewmar.com/find-my-hatch



The Lewmar Portlight Range



Page 168 Flush Mitre Portlight

- Number of textures, angles and levels is minimised in order to minimise the visual impact of the portlight on the boat
- Acrylic almost flush with the mounting surface
- 12mm acrylic is used in order to achieve the flush effect
- Flat outer frame
- Outer frame powder-coated black to camouflage with the acrylic lens



Page 170 Stainless Steel Portlight

- Polished stainless outer frame with no joint
- Handles and hinges are fitted to the edge of the lens to allow clear visibility
- ABS plastic inside trim can be cut to length
- Friction hinges hold the window open



Page 172 Standard Portlight

- The Standard Portlight is fitted to thousands of boats throughout the world
- Aluminium external frame
- Handles and hinges are fitted to the edge of the lens to allow clear visibility
- Quick-action handles
- ABS plastic inside trim can be cut to length
- Friction hinges hold the window open



Page 174 Atlantic Portlight

- Stronger aluminium outer frame with single welded joint
- Lens bonded into alloy frame for additional stiffness
- Stainless 316 handles
- Aluminium inside trim
- Small opening sizes (10,30 & 32) CE Approved for in-hull installation
- Friction hinges hold the window open



Page 176 Custom Portlight Solutions

- Concept 3 Portlight - Designed to be installed into larger expanses of acrylic. A ventilation solution that does not compromise aesthetics
- Trimports - Flush lines and large apertures. An almost limitless solution for coachroof design



Page 178 Portlight Spares and Accessories

- Flyscreens
- Spare acrylics, hinges, handles etc.
- Portlight Identification Guide

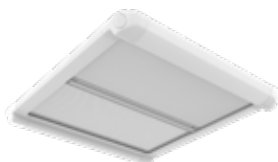

Page 180 Shades

- A selection of flyscreen and blackout shade solutions
- Surface-mounted and flush solutions available
- Easy installation and operation

4. Hatch & Portlight



Flush Mitre Portlight

Complementing the styling of the Lewmar Flush Hatch, the Flush Mitre Portlight offers a seamless line from the hull across the portlight. When installed into acrylic, the Flush Mitre Portlight offers a ventilation solution within the illusion of a larger opening.

- Development of Lewmar Standard Portlight
- Flat outer frame powder-coated black for minimal visual impact
- Acrylic almost flush with the mounting surface
- Flyscreen not supplied as standard

Specifications options:

- Handles: clip (standard) / twist (option)
- Acrylic window 12mm (1/2") colour: grey or dark grey
- Frame colour: Powder-coated black

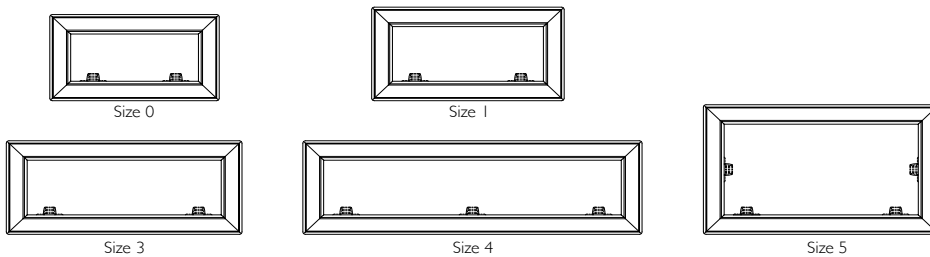
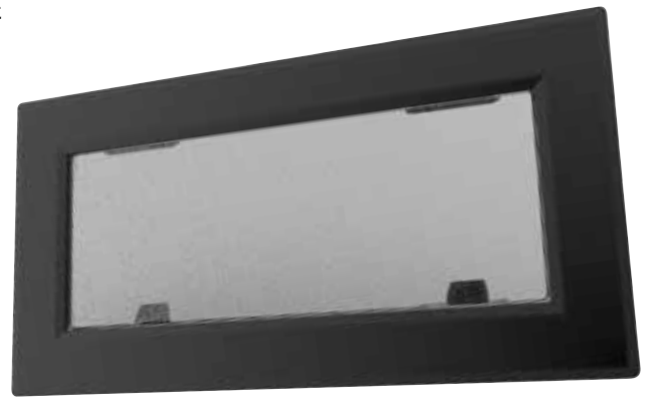

Portlight Valance & Fastening Required

HULL THICKNESS	FASTENING	
3.5 TO 6.5 MM	361799999	M5 X 12MM LONG
7 TO 9 MM	361800999 ¹	M5 X 16MM LONG

Standard valance suit hull thickness 3.5 to 9mm. Other valance type available for thicker hull up to 17.5mm. Contact Lewmar for more information

¹ Supplied as standard with portlight listed below
Fastenings supplied in bags of 100

Flush Mitre Portlight Dimensions

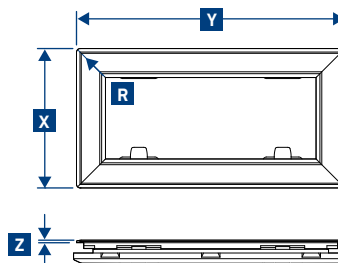

Cut-out Dimensions

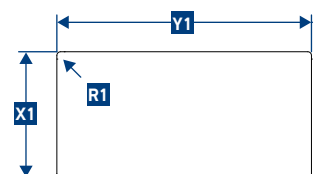



Flush Mitre Portlight Specifications

PART NUMBER GREY	PART NUMBER DARK GREY	SIZE	OVERALL DIMENSIONS								CUT-OUT DIMENSIONS						PORTLIGHT WEIGHT	
			X WIDTH		Y LENGTH		Z HEIGHT		R RADII		X1 WIDTH		Y1 LENGTH		R1 RADII			
			MM	IN	MM	IN	MM	IN	MM	IN	MM	IN	MM	IN	MM	IN	MM	IN
393029800	393029802	0	175	6 7/8	322	12 11/16	4	5/32	5	3/16	156	6 1/8	303	11 15/16	5	3/16	1.3	2.9
393129800	393129802	1	190	7 1/2	366	14 7/16	4	5/32	5	3/16	171	6 3/4	347	13 11/16	5	3/16	1.6	3.5
393329800		3	190	7 1/2	448	17 11/16	4	5/32	5	3/16	171	6 3/4	429	16 7/8	5	3/16	2.0	4.4
393429800		4	190	7 1/2	645	25 7/16	4	5/32	5	3/16	171	6 3/4	626	24 11/16	5	3/16	2.8	6.2
393529800		5	263	10 11/32	448	17 5/8	4	5/32	5	3/16	244	9 5/8	429	16 7/8	5	3/16	2.6	5.7

Flush Mitre Custom Size Portlight Specifications

PART NUMBER GREY	PART NUMBER DARK GREY	FLYSCREEN	OVERALL DIMENSIONS								CUT-OUT DIMENSIONS					
			X WIDTH		Y LENGTH		Z HEIGHT		R RADII		X1 WIDTH		Y1 LENGTH		R1 RADII	
			MM	IN	MM	IN	MM	IN	MM	IN	MM	IN	MM	IN	MM	IN
30216000		30277800	115	4 1/2	322	12 43/64	4	5/32	5	3/16	96	3 25/32	303	11 15/16	5	3/16
	30179600		180	7 5/64	490	19 9/32	4	5/32	5	3/16	161	6 11/32	471	18 35/64	5	3/16
30183700		30222000	150	5 29/32	600	23 5/8	4	5/32	5	3/16	131	5 5/32	581	22 7/8	5	3/16
	30184900		200	7 7/8	490	19 9/32	4	5/32	5	3/16	181	7 1/8	471	18 35/64	5	3/16
30187100			270	10 5/8	900	35 7/16	4	5/32	5	3/16	251	9 7/8	881	34 11/16	5	3/16
30196200		30206400	360	14 11/64	500	19 11/16	4	5/32	5	3/16	341	13 27/64	481	18 15/16	5	3/16
30196300		30206500	300	11 13/16	564	22 16/64	4	5/32	5	3/16	281	11 1/16	545	21 29/64	5	3/16
30196400		30206600	360	14 11/64	680	26 49/64	4	5/32	5	3/16	341	13 27/64	661	26	5	3/16
30198700		30206300	338	13 19/64	360	14 11/64	4	5/32	5	3/16	319	12 9/16	341	13 27/64	5	3/16
30203300			440	17 21/64	354	13 15/16	4	5/32	5	3/16	421	16 37/64	335	13 3/16	5	3/16

FLYSCREEN NOT SUPPLIED AS STANDARD
 CE APPROVAL TO CATEGORY A, AREA 2B FOR SIZES UP TO 200X600.

Flush Mitre Fixedlight Specifications

PART NUMBER GREY	PART NUMBER DARK GREY	PART NUMBER CLEAR	OVERALL DIMENSIONS								CUT-OUT DIMENSIONS					
			X WIDTH		Y LENGTH		Z HEIGHT		R RADII		X1 WIDTH		Y1 LENGTH		R1 RADII	
			MM	IN	MM	IN	MM	IN	MM	IN	MM	IN	MM	IN	MM	IN
30192000	30183800	30192200	150	5 29/32	600	23 5/8	4	5/32	5	3/16	131	5 5/32	581	22 7/8	5	3/16
30212200			174	6 7/8	423	16 21/32	4	5/32	5	3/16	155	6 7/64	404	15 29/32	5	3/16
	30211800		193	7 19/32	648	25 33/64	4	5/32	5	3/16	174	6 35/64	629	24 49/64	5	3/16
30212200			240	9 29/64	700	27 9/16	4	5/32	5	3/16	221	8 45/64	681	26 13/16	5	3/16

CE APPROVAL TO CATEGORY A, AREA 1 ON SIZE 150X600

4. Hatch & Portlight



Stainless Steel Portlight

With its highly polished stainless outer frame, the Stainless Portlight offers a clean, modern look. The handles and hinge system are designed to leave the lens clear of obstructions, giving an uncluttered view.

- ABS plastic trim
- Easily fitted by clamping the cabin sides between inner and outer frame with screws provided that are fastened into the outer frame
- Can be installed with sealant or closed cell PVC tape
- Trim with clean styling
- Full range of spare parts available online at www.lewmar.com

Specifications options:

- Handles: clip (standard) / twist (option)
- Moulding colour: grey
- Acrylic colour: grey (standard), other colours available
- Frame colour: stainless steel
- Comes complete with trim and flyscreen



Stainless steel Portlight Dimensions

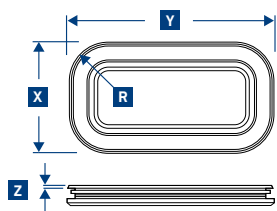

Stainless steel Portlight Cut-out

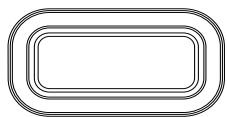
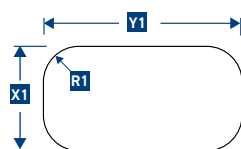

Size 0

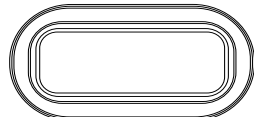

Size 1

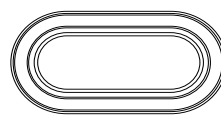

Size 1RE

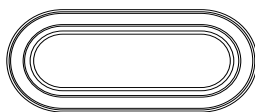

Size 7RE



Size 8



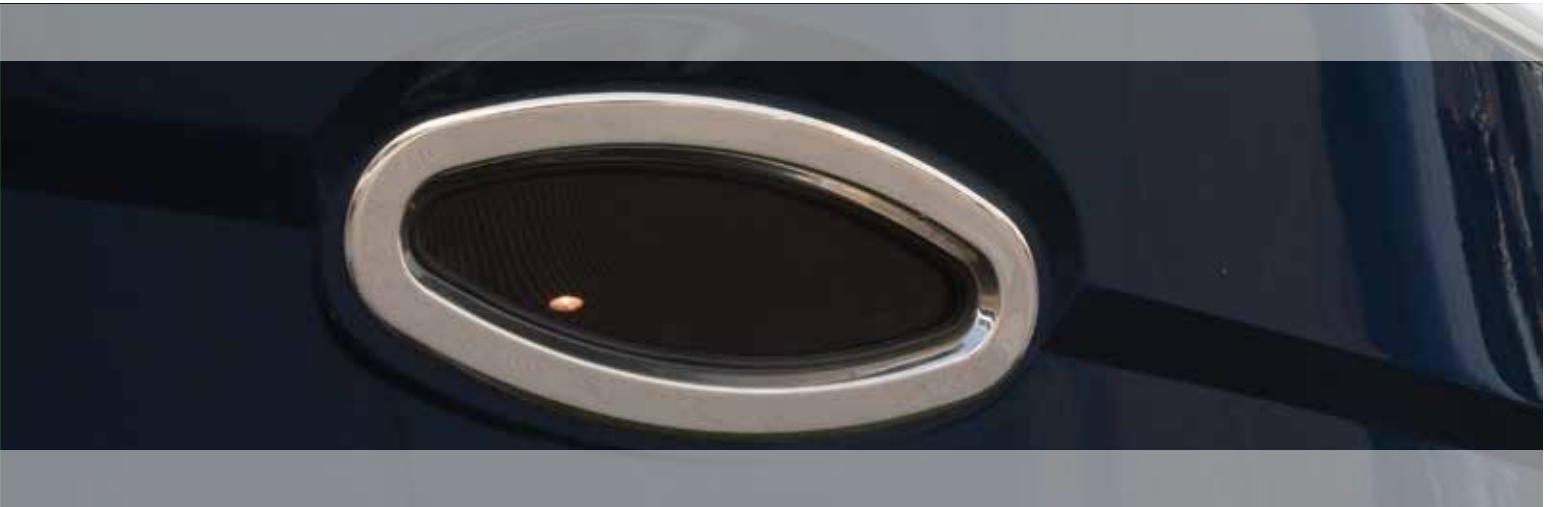

PART NUMBER	SIZE	TRIM COLOUR	VERSION	OVERALL DIMENSIONS								CUT-OUT DIMENSIONS						PORTLIGHT WEIGHT		ACRYLIC WINDOW THICKNESS	
				X LENGTH		Y WIDTH		Z HEIGHT		R RADI		X1 LENGTH		Y1 WIDTH		R1 RADI					
				MM	IN	MM	IN	MM	IN	MM	IN	MM	IN	MM	IN	MM	IN	MM	IN	KG	LB
393020262	0	WHITE	OPENING	176	6 15/16	323	12 11/16	4	5/32	62.0	2 7/16	156	6 1/8	303	12	52.0	2 1/16	1.5	3.30	8	1/2
393010262	0	WHITE	FIXED	176	6 15/16	323	12 11/16	4	5/32	62.0	2 7/16	156	6 1/8	303	12	52.0	2 1/16	1.5	3.30	10	3/8
393120262	1	WHITE	OPENING	191	7 1/2	367	14 7/16	4	5/32	62.0	2 7/16	171	6 3/4	347	13 5/8	52.0	2 1/16	1.7	3.80	8	1/2
393110262	1	WHITE	FIXED	191	7 1/2	367	14 7/16	4	5/32	62.0	2 7/16	171	6 3/4	347	13 5/8	52.0	2 1/16	1.7	3.80	10	3/8
393180262	1RE	WHITE	OPENING	191	7 1/2	367	14 7/16	4	5/32	95.5	3 3/4	171	6 3/4	347	13 5/8	85.5	3 3/8	1.7	3.74	10	3/8
393170262	1RE	WHITE	FIXED	191	7 1/2	367	14 7/16	4	5/32	95.5	3 3/4	171	6 3/4	347	13 5/8	85.5	3 3/8	1.7	3.74	10	3/8
393780262	7RE	WHITE	OPENING	191	7 1/2	425	16 3/4	4	5/32	95.5	3 3/4	171	6 3/4	405	15 15/16	85.5	3 3/8	1.9	4.18	10	3/8
393770262	7RE	WHITE	FIXED	191	7 1/2	425	16 3/4	4	5/32	95.5	3 3/4	171	6 3/4	405	15 15/16	85.5	3 3/8	1.9	4.18	10	3/8
393820862	8	CHROME	OPENING	196	7 11/16	452	17 13/16	4	5/32	N/A	N/A	SEE DRAWING ON WEBSITE						1.9	4.18	10	3/8
393810862	8	CHROME	FIXED	196	7 11/16	452	17 13/16	4	5/32	N/A	N/A	SEE DRAWING ON WEBSITE						1.9	4.18	10	3/8

Round Stainless Steel Portlight

Round stainless steel Portlight Dimensions

Cut-out Dimensions

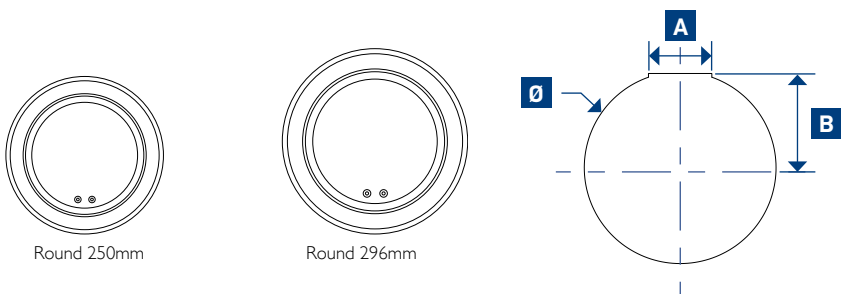

Round Stainless Steel Portlight Specifications

PART NUMBER	TRIM COLOUR	VERSION	OVERALL Ø		CUT-OUT DIAMETER						WEIGHT		THICKNESS	
			MM	IN	Ø	A		B		KG	LB	MM	IN	
						MM	IN	MM	IN					
30209800	CHROME	OPENING	250	9 7/8	230	9 1/16	76	3	113	4 7/16	1.4	3	10	3/8
30209900	CHROME	OPENING	296	11 5/8	277	10 7/8	100	3 15/16	136	5 3/8	2.0	4	10	3/8

Maximum hull thickness 24mm

Minimum hull thickness 8mm

All portlights are supplied with M5 x 12 fastenings

Flyscreen available for the Round Stainless Portlights

4. Hatch & Portlight



Standard Portlight

A perfect match for any hatch in the Lewmar range, the Standard Portlight is stylish, competitively priced and easy to use and install.

- Easily fitted by clamping the cabin sides between inner and outer frame with screws that are fastened into the outer frame
- Can be installed with sealant or closed cell PVC tape
- White ABS Plastic Trim
- Cut out shape available from www.lewmar.com
- Supplied complete with flyscreen (except sizes 4L and 4R)
- Full range of spare parts available on-line www.lewmar.com

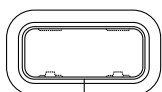

Size 0

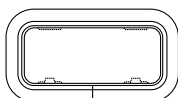

Size 1

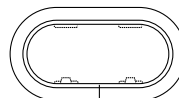

Size 1RE

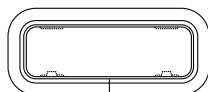

Size 2

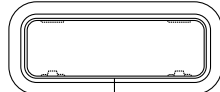

Size 3



Size 4

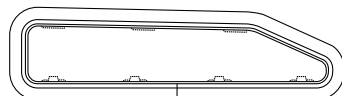

Size 4R

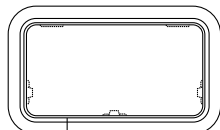

Size 5

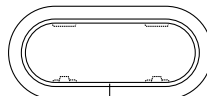

Size 7RE

CE
Approved

ALL SIZES
AREA 2A.
SEE PAGE 132

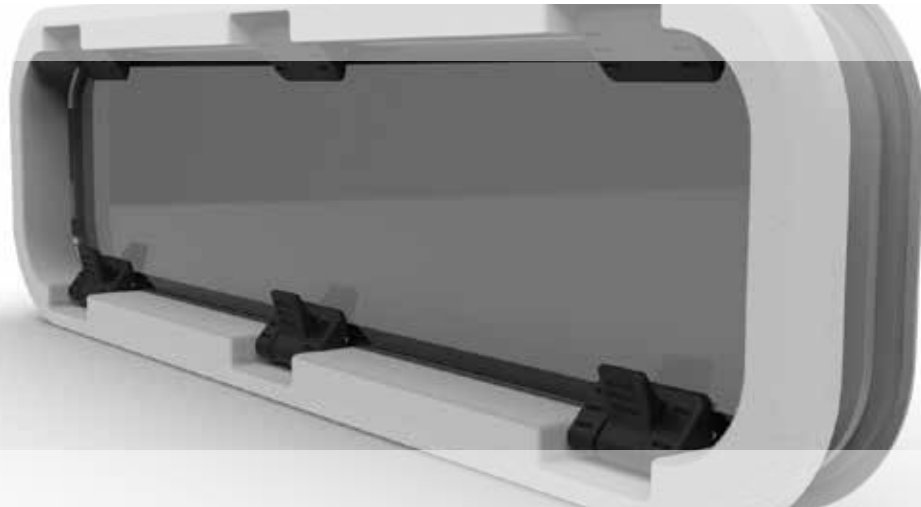

Specifications options:

- Handles: clip (standard) / twist (option)
- Moulding colour: grey
- Acrylic colour: grey (standard), other colours available
- Frame colour: Silver anodized (standard), other finishes available
- Come complete with trim and flyscreen



Optional twist handle, contact your Lewmar representative for part numbers

Standard Portlight Dimensions

Standard Portlight Cut-out

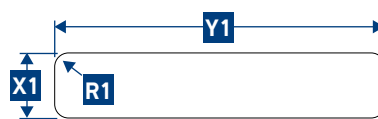
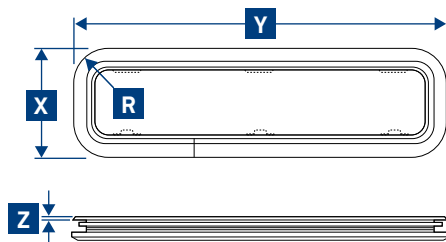

PART NUMBER	SIZE	OVERALL DIMENSIONS										CUT-OUT DIMENSIONS						PORTLIGHT WEIGHT		ACRYLIC WINDOW THICKNESS	
		X LENGTH		Y WIDTH		Z HEIGHT		R RADI		X1 LENGTH		Y1 WIDTH		R1 RADI		KG	LB	MM	IN		
393020200	0	176	6 15/16	323	12 11/16	4	5/32	62.0	2 7/16	156	6 1/8	303	11 15/16	52.0	2 1/16	1.1	2.42	6	1/4		
393120200	1	191	7 1/2	367	14 7/16	4	5/32	62.0	2 7/16	171	6 3/4	347	13 11/16	52.0	2 1/16	1.3	2.86	6	1/4		
393180200	1RE	191	7 1/2	367	14 7/16	4	5/32	95.5	3 3/4	171	6 3/4	347	13 11/16	85.5	3 3/8	1.3	2.86	8	5/16		
393220200	2	176	6 15/16	425	16 3/4	4	5/32	62.0	2 7/16	156	6 1/8	405	15 5/16	52.0	2 1/16	1.4	3.08	8	5/16		
393320200	3	191	7 1/2	449	17 11/16	4	5/32	62.0	2 7/16	171	6 3/4	429	16 7/8	52.0	2 1/16	1.7	3.74	10	3/8		
393420200	4	191	7 1/2	646	25 7/16	4	5/32	62.0	2 7/16	171	6 3/4	626	24 11/16	52.0	2 1/16	2.4	5.28	8	5/16		
393440200	4R	195	7 11/16	708	27 7/8	4	5/32	62.0	2 7/16	175	6 7/8	688	27 1/16	52.0	2 1/16	2.4	5.28	8	5/16		
393460200	4L	195	7 11/16	708	27 7/8	4	5/32	62.0	2 7/16	175	6 7/8	688	27 1/16	52.0	2 1/16	2.4	5.28	8	5/16		
393520200	5	264	10 3/8	449	17 11/16	4	5/32	62.0	2 7/16	244	9 5/8	429	16 7/8	52.0	2 1/16	2.3	5.15	10	3/8		
393780200	7RE	191	7 1/2	425	16 3/4	4	5/32	95.5	3 3/4	171	6 3/4	405	15 15/16	85.5	3 3/8	2.4	5.28	8	5/16		

Maximum hull thickness 34mm

Minimum hull thickness 7mm

All portlights are supplied with 12 off M5 x 25 screws for hull thickness 17-25mm

Portlights should be fitted to a flat surface +/- 1mm

4. Hatch & Portlight



Atlantic Portlight

The Atlantic Portlight has clean lines and proven offshore pedigree.

- Extensive range
- Flyscreens provided as standard
- Friction hinges
- Screw handles available as an option
- Full range of spare parts available on-line www.lewmar.com

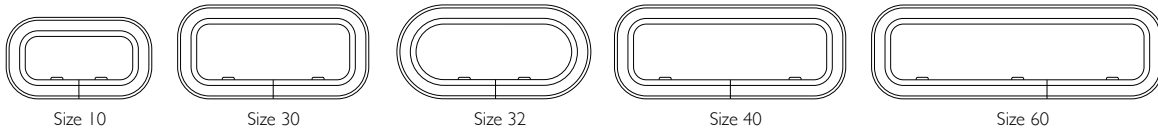

Specifications options:

- Clip handles standard / Screw handles optional
- Acrylic colour: Grey (standard) other colour optional
- Frame colour: Silver anodized (standard) other finish available
- Come complete with alloy valance and flyscreen
- Portlights and fixed lights come complete with fastenings as indicated in the table

Portlight Valance & Fastening

HULL THICKNESS MM	VALANCE TYPE	FASTENING	
8-10	THIN HULL VALANCE	360360999 ¹	M5 X 12MM LONG
11-15	THIN HULL VALANCE	360361999	M5 X 16MM LONG
16-19	THICK HULL VALANCE	360362999	M5 X 20MM LONG
20-24	THICK HULL VALANCE	360363999 ²	M5 X 25MM LONG

¹ Supplied as standard with thin hull valances

² Supplied as standard with thick hull valances

Fastenings supplied in bags of 100



Atlantic Portlight Dimensions

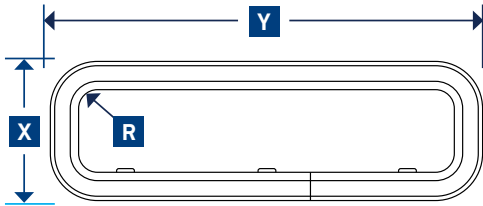

Atlantic Portlight Cut-out

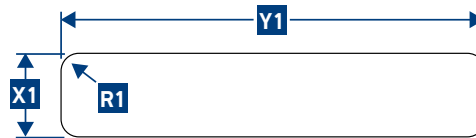

PART NUMBER		SIZE	OVERALL DIMENSIONS								CUT-OUT DIMENSIONS						PORTLIGHT WEIGHT		ACRYLIC WINDOW THICKNESS	
THIN VALANCE	THICK VALANCE		X LENGTH		Y WIDTH		Z HEIGHT		R RADII		X1 LENGTH		Y1 WIDTH		R1 RADII		KG	LB	MM	IN
39110090	39110070	10	174	6 15/16	304	12	6	1/4	71	2 13/16	154	6 1/16	284	11 3/16	61	2 3/8	1.6	3.5	8	5/16
39130090	39130070	30	200	7 7/8	400	15 3/4	6	1/4	71	2 13/16	180	7 1/16	380	14 15/16	61	2 3/8	2.2	4.8	8	5/16
39132090	39132070	32	198	7 13/16	401	15 13/16	6	1/4	99	3 7/8	178	7	381	15	89	3 1/2	2.1	4.6	8	5/16
39140090	39140070	40	200	7 7/8	480	18 7/8	6	1/4	71	2 13/16	180	7 1/16	460	18 1/8	61	2 3/8	2.5	5.5	8	5/16
39160090	39160070	60	200	7 7/8	600	23 5/8	6	1/4	71	2 13/16	180	7 1/16	580	22 13/16	61	2 3/8	3.0	6.6	8	5/16

Specifications options:

- Smoke grey acrylic and silver anodise frames
- Should be fitted to a flat surface with a max tolerance of ± 1 mm
- Come complete with fastenings as indicated on above table
- Portlight opening is restricted on very thick hulls.
- At 24mm hull thickness opening angle is 115°

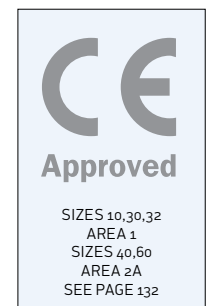

4. Hatch & Portlight



Concept 3 Portlight

The Concept 3 portlight enables the integration of an opening portlight into larger expanses of acrylic. Discreet fastenings and a thin exterior frame minimise the aesthetic compromise as much as possible.

Supplied as a discrete unit, the Concept 3 provides an additional option for boat builders to offer their customers who desire additional ventilation without compromising design or watertight integrity.

- Supply ventilation into the cabin without compromising sleek design lines
- Portlight designed to sit flush in a 8mm thick panel/coachroof
- Seal design based on our proven New Standard platform

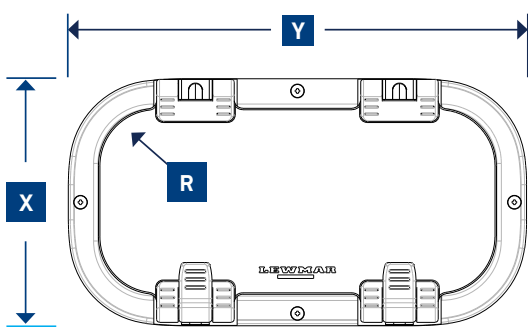

PART NUMBER	FLYSCREEN	OVERALL DIMENSIONS						CUT-OUT DIMENSIONS						ACRYLIC WINDOW THICKNESS		CE CERTIFICATION
		X LENGTH		Y WIDTH		R RADII		X1 LENGTH		Y1 WIDTH		R1 RADII		MM	IN	
30193600	30204400	319	12 1/2	172	6 3/4	61	2 1/2	280	11	133	5 1/4	39	1 1/2	25	1	CATEGORY A, AREA 2B
30216100		360	14 3/16	162	6 3/8	61	2 1/2	321	12 5/8	123	4 13/16	39	1 1/2	25	1	CATEGORY B, AREA 1

FLYSCREEN NOT SUPPLIED AS STANDARD
CE APPROVAL TO CATEGORY A, AREA 2B FOR SIZES UP TO 200X600.



Flush Trimports

The Flush Trimport provides yacht designers with an alternative way of styling the coachroof coaming.

The trimport is a long, thin, outward opening hatch. On the outside of the yacht a long, uninterrupted panel provides a supremely smooth aesthetic. The outward opening removes the issue experienced with conventional portlights of water running off the lens and into the boat.

Flush Trimports must be integrated into the vessel at the design stage as custom shapes are required for each boat model.

- Based on flush hatch platform
- Flexible sizing to suit OEM requirements
- Flyscreen not supplied as standard
- Contact Lewmar for further information

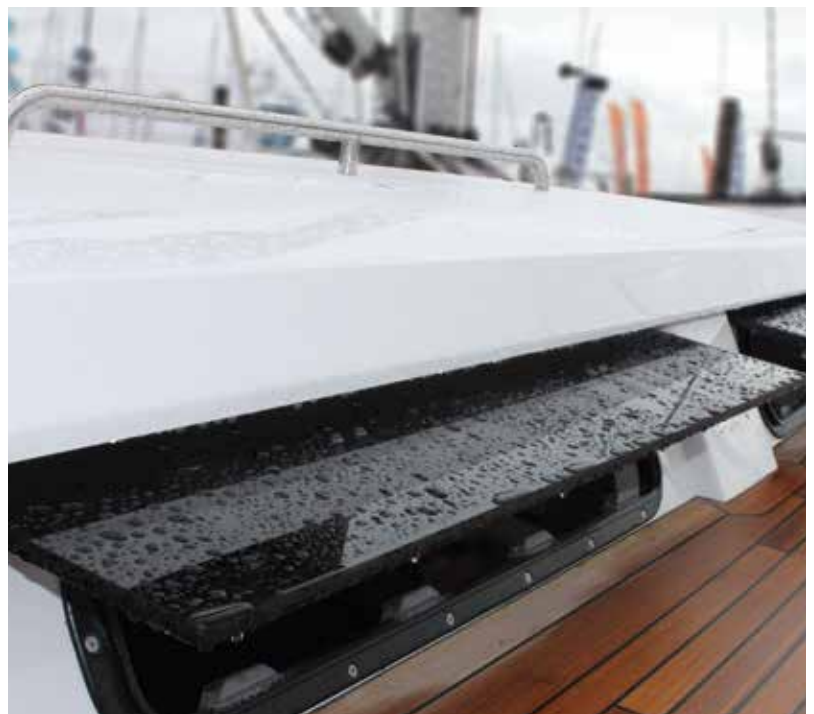

4. Hatch & Portlight

Portlight Accessories and Spares

Portlight Flyscreen

Portlight Flyscreen provides easy installation and removal.

Note: Portlight cannot be closed with flyscreen in place



Standard Portlight Clip Flyscreens



PART NUMBER	TO SUIT STANDARD PORTLIGHT
367302936	SIZE 0
367312936	SIZE 1
367318936	SIZE 1RE
367322936	SIZE 2
367332936	SIZE 3
367342936	SIZE 4
367352936	SIZE 5
367378936	SIZE 7RE

Atlantic Portlight Clip Flyscreens



PART NUMBER	TO SUIT ATLANTIC PORTLIGHT
367110936	SIZE 10
367130936	SIZE 30
367132936	SIZE 32
367140936	SIZE 40
367160936	SIZE 60

Stainless Portlight Flyscreens



PART NUMBER	TO SUIT STAINLESS PORTLIGHT
367318966	SIZE 1RE
367378966	SIZE 7RE
367382966	SIZE 8 ELLIPTICAL

PART NUMBER	TO SUIT ROUND STAINLESS PORTLIGHT
30204300	SIZE 250
30205100	SIZE 296

Portlight Fastenings

PART NUMBER	SCREW SIZE	HULL THICKNESS mm			
		STANDARD PORTLIGHT		STAINLESS STEEL PORTLIGHT	
		MIN	MAX	MIN	MAX
19899000	M5 X 12	7	9	7	9
19899100	M5 X 16	8	13	8	13
19899200	M5 X 20	12	17	12	17
19899300	M5 X 25	17	22	17	22
19899400	M5 X 30	22	27	22	27
19899500	M5 X 35	27	32	27	32
19899600	M5 X 40	32	34	32	34

Screws supplied in quantities of 100

New Standard Seal

PART NO	PORTLIGHT SIZE
360758999	0
360759999	1
360760999	2
360761999	3
360762999	4
360763999	4L
360763999	4R
360765999	5
361010999	7RE

Flush Mitre Acrylic

For over cam handles

PART NO	SIZE
361724029	0 (GREY)
361725029	1 (GREY)
361726029	3 (GREY)
361727029	4 (GREY)
361728029	5 (GREY)
361724829	0 (DARK GREY)
361725829	1 (DARK GREY)
361726829	3 (DARK GREY)
361727829	4 (DARK GREY)

New Standard Acrylic

For Mk 2 (post-2000) portlights with over cam handles

PART NO	SIZE
360750009	0
360751009	1
360752009	2
360753009	3
360754009	4
360755009	4L
360756009	4R
360757009	5
361009009	7RE

Atlantic Portlight Lid Spare

For opening portlights

PART NO	SIZE
360532009	10
360533009	30
360534009	32
360684009	40
360686009	60

How To Identify Your Lewmar Portlight

Portlights Produced after October 1997 (with the exception of the Old Standard) have Lewmar, the name of the range, the portlight size, and a date code stamped on the acrylic.

All models available in opening, Portlights, or non-opening versions, Fixedlights.

IDENTIFYING FEATURES	OLD STANDARD	NEW STANDARD	ATLANTIC MK.1	OCEAN
PRODUCTION DATES	1982 - 1998	1997 - NOW	1994 - NOW	1990 - 2000
ALLOY FRAME AROUND ACRYLIC			*	*
PLASTIC HANDLES TURN LIKE KEYS TO OPEN	*			
PLASTIC HANDLES PUSH TO CLOSE		*		*
METAL HANDLES PUSH TO CLOSE			*	
PORTLIGHT CLICKS THROUGH POSITIONS AT WHICH WILL STAY OPEN	*			*

(Old) Standard Portlight

- Produced 1982-1998
- No frame around acrylic
- Plastic handles and hinges fastened through acrylic
- Plastic turn to close handles
- 2 frame joins on outside of portlight



New Standard Portlight

- Produced 1997 to date
- No frame around acrylic
- Plastic handles and hinges glued to acrylic
- Plastic push to close handles
- 1 frame join on outside of portlight
- Interior ABS trim clips into place
- Interior ABS trim fitted with velcro type strips.
- Seals, Hinges & Acrylics still available for standard sizes



Atlantic Portlight

- Produced 1994 to date
- Alloy frame around acrylic
- Metal push to close handles
- 1 frame joint in outside of portlight
- Alloy interior trim



Ocean Portlight

- Produced 1990 to 2000
- One size available
- Alloy frame around acrylic
- Plastic handles push sideways to close handles
- Cast frame - no joins on outside of portlight
- Interior ABS trim fitted with velcro type strips.
- Deadlights available



4. Hatch & Portlight



Roller Shade

Designed for the perfect fit to our existing range of hatches, the new modular blind system complements today's stylish interiors. Easy to assemble, fit, maintain and adjust, our new shade range is the perfect addition to our great hatch & portlight range.

All components have been specially selected for their suitability in withstanding the harsh marine environment. The chosen polymers and fabrics are designed to look good within the interior of any boat and are easy to keep clean and offer excellent resistance to damp conditions. Simple and clean in design, our range will complement the internal styling of your boat and provide you with a perfect solution to insect and light protection.

Finding a hatch or port shade to match what you need has never been easier:

- Easy to install – 4 simple parts
- 100% blackout material that is UV stable, wipe clean and water repellent
- Durable flyscreen mesh, providing protection and airflow
- Low profile design
- Adjustable tensioning mechanism
- Suitable for all Lewmar standard hatch sizes
- Internal trims also available





▪ **Design**

Modular joining system for simple installation and maintenance

▪ **Connectors**

Magnetic connectors for easy stowing and operation

▪ **Fabrics**

Moisture- and mould-resistant fabrics make up the blackout solar shade & Lewmar flyscreen

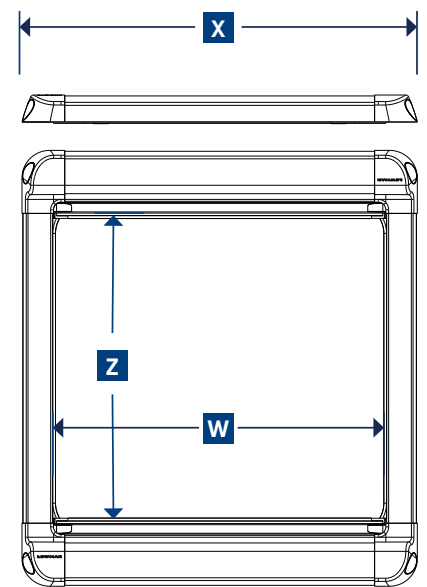
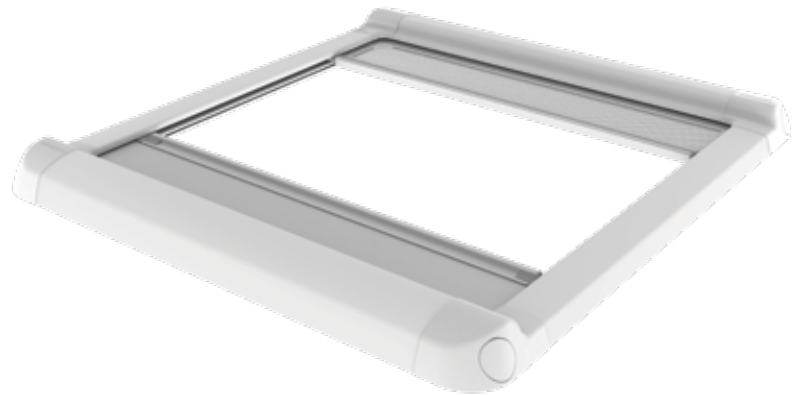

PART NUMBER	SIZE	W OPENING WIDTH	Z OPENING HEIGHT	X OVERALL WIDTH	Y OVERALL HEIGHT
367710100	10	262	262	344	398
367720100	20	349	204	431	340
367730100	30	459	329	541	465
367740100	40	423	423	505	559
367741100	41	423	178	505	314
367744100	44	444	444	526	580
367750100	50	509	379	591	515
367754100	54	509	394	591	530
367760100	60	509	509	591	645
367770100	70	629	629	711	765
367780100	78	721	771	803	907

4. Hatch & Portlight



Pleated Shade

Designed on the Lewmar platform, the pleated design offers the reliable modular configuration of the roller shade combined with stylish & contemporary pleated fabrics.

From size 10 to 70, Pleated shade is an elegantly pleated flyscreen and 100% blackout blind. While the blackout blind provides absolute darkness, the flyscreen yields atmospheric and pest free conditions. Simple and clean in design, the pleated shade can be mounted directly to the headlining of any vessel or can be mounted in the headlining as a flush pleated solution.

- Easy to install – surface or flush mount option
- 100% honeycomb black out material, UV stable
- Low profile design
- Suitable for all Lewmar standard hatch sizes
- Internal trims also available





▪ **Design**

Modular design that can be mounted direct to the headlining or in a flush application

▪ **Connectors**

Magnetic connectors for simple, easy stowing and movement between screens

▪ **Fabrics**

Moisture- and mould-resistant fabrics with pleated 100% blackout solar shade & Lewmar pleated flyscreen



PART NUMBER	SIZE	W OPENING WIDTH	Z OPENING HEIGHT	X OVERALL WIDTH	Y OVERALL HEIGHT
367710400	10	263	263	306	306
367720400	20	350	205	393	248
367730400	30	460	330	503	373
367740400	40	424	424	467	467
367744400	44	445	445	488	488
367750400	50	381	510	424	553
367754400	54	510	395	553	438
367760400	60	510	510	553	553
367770400	70	630	630	673	673

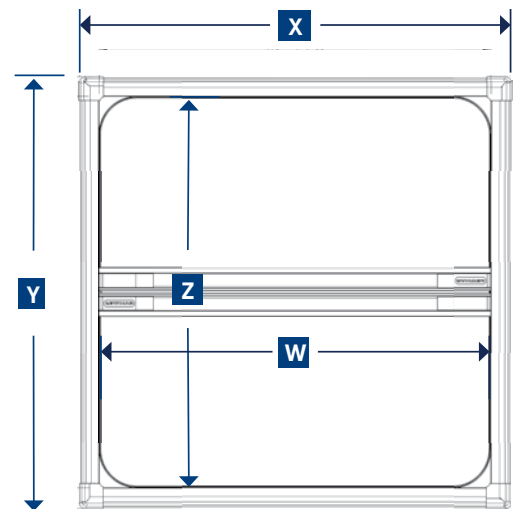

4. Hatch & Portlight

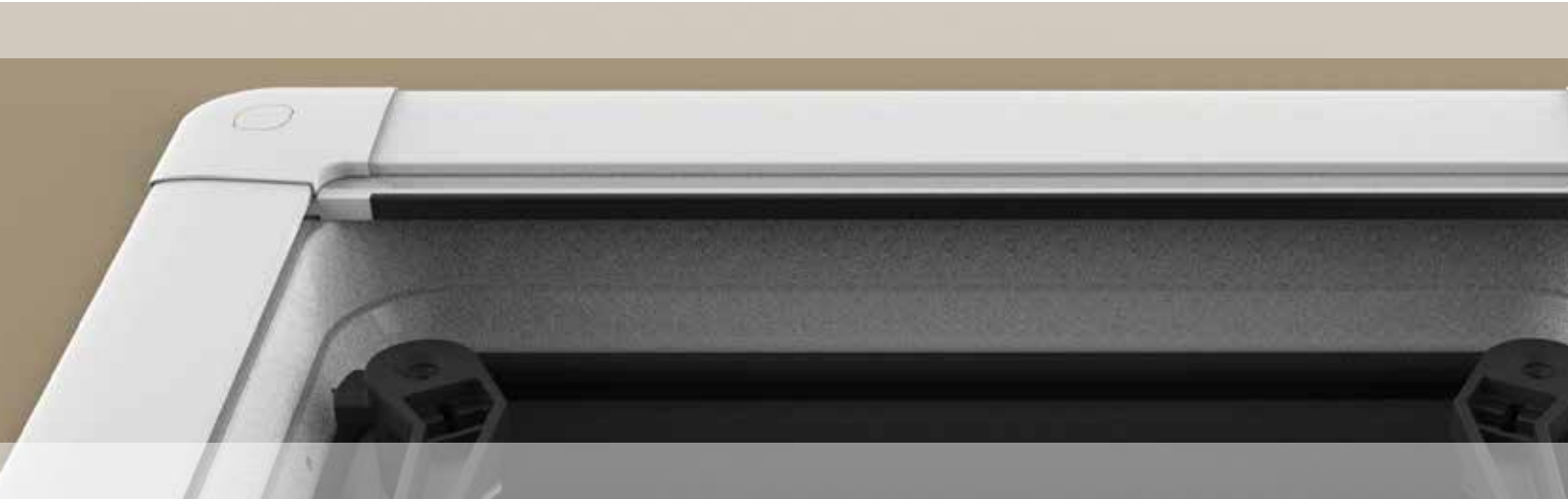

Flush Roller Shade

The Lewmar Flush Roller Shade is available as an integrated OEM solution, designed to offer the reliable modular configuration of the Lewmar Roller Shade in a stylish and contemporary flush solution.

Designed to sit flush within a yacht's headlining, the Flush Roller is a design for the fast-paced OEM market. With a durable and stylish composite extrusion, the shade is fitted with a Lewmar flyscreen and blackout shade. Designed to match Lewmar hatch sizes 10 to 70, this new flush design offers a seamless look in your cabin while retaining all the benefits of the Lewmar Roller Shade systems.

- Easy to install – 4 simple parts
- 100% black out material that is UV stable, wipe clean and water repellent
- Durable flyscreen mesh, providing protection and airflow
- Adjustable tensioning mechanism
- Flush design
- Suitable for all Lewmar standard hatch sizes
- Internal trims also available





▪ **Design**

Flush modular joining system for simple installation and maintenance

▪ **Connectors**

Magnetic connectors for easy stowing and movement of screens

▪ **Fabrics**

Moisture- and mould-resistant fabrics with blackout solar shade and Lewmar flyscreen

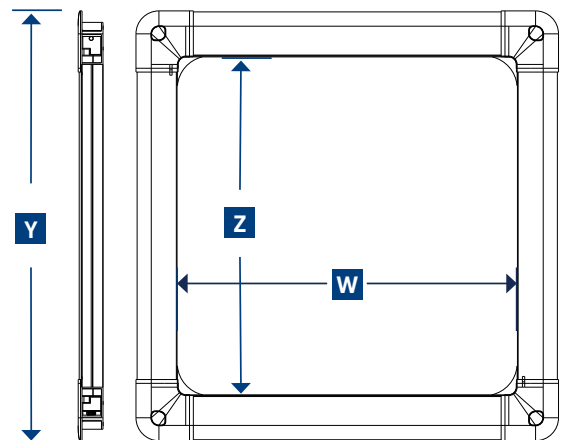

PART NUMBER	SIZE	OPENING WIDTH (W)	OPENING HEIGHT (Z)	OVERALL WIDTH (X)	OVERALL HEIGHT (Y)
367710200	10	263	263	371	381
367720200	20	350	205	458	323
367730200	30	460	330	568	448
367740200	40	424	424	532	542
367744200	44	445	445	553	563
367750200	50	381	510	489	628
367754200	54	510	395	618	513
367760200	60	510	510	618	628
367770200	70	630	630	738	748

4. Hatch & Portlight



Portshade

Designed for the perfect fit to our existing range of portlights, the Portshade system complements our range of shades.

Quick and simple to install, the Lewmar Portshade is a low profile cassette roller blind, suitable for Lewmar portlight sizes 0 to 5. Portshades can be mounted vertically or horizontal, with the added advantage of being perfectly suited for the curved surface application.

- Easy to install – 2 simple parts
- 100% black out material that is UV stable, wipe clean and water repellent
- Compatible with standard Lewmar portlight sizes

Design

Simple fitting with 2 screw installation, suitable for vertical or horizontal mounting

Fabric

100% black out material that is UV stable, wipe clean and water repellent

Fixing

Stylish pull down tabs and easy-locking catch

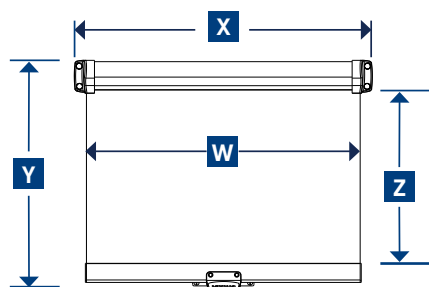

PART NUMBER	SIZE	X OVERALL WIDTH	Y OVERALL HEIGHT	W SHADE WIDTH	Z SHADE HEIGHT
367700300	SIZE 0	409	422	340	280
367710300	SIZE 1 / 1RE	449	422	380	280
367730300	SIZE 2/3/5	529	462	460	320
367740300	SIZE 4	729	462	660	320
367745300	SIZE 4R / 4L	789	462	720	320

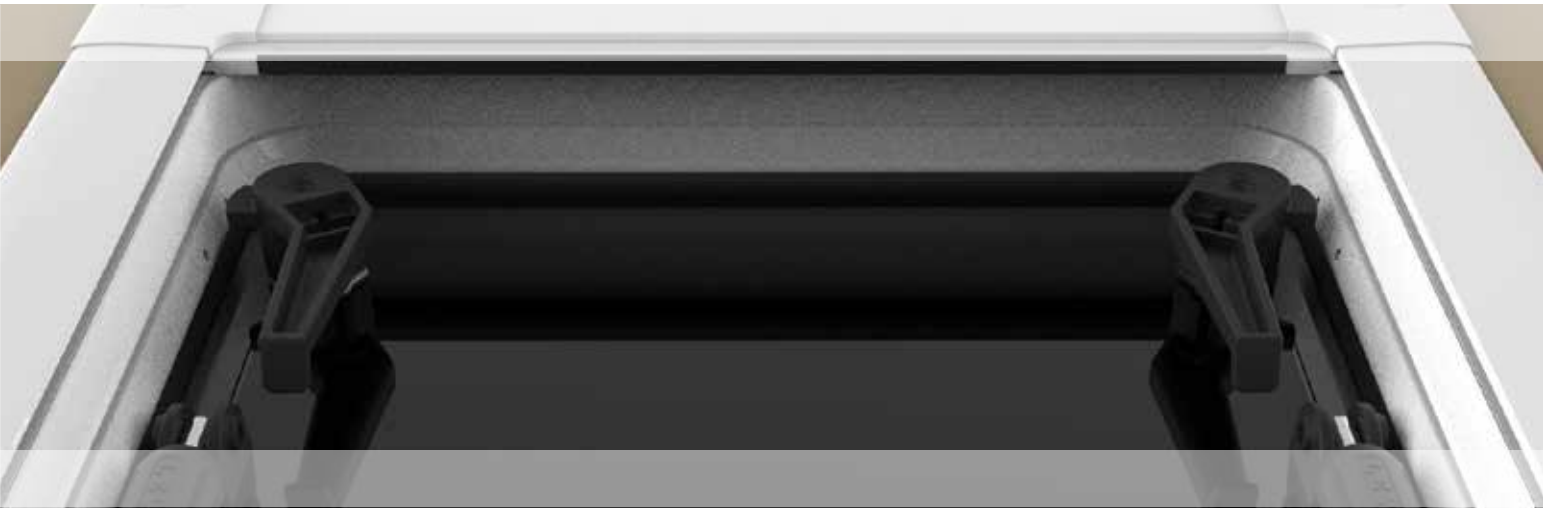

Trim Kits

Complements and covers any gaps between the shade and hatch frame. The trim clips into the shades, simply cut down to adjust to fit any hatch depth.

- Accommodates all Lewmar hatch sizes
- Minimalist and stylish design, hard wearing and easy to clean
- UV resistant material, durable, light reflective and light weight



PART NO.	SIZE
367710150	10
367720150	20
367730150	30
367740150	40
367744150	44
367750150	50
367754150	54
367760150	60
367770150	70

