

## Attention! Read these instructions...

### HOW TO PRINT THIS PATTERN

Please follow these instructions to print. You will need standard A4, letter, or larger paper:

- From the Adobe Acrobat main window, go to **File > Print...**
- Select the printer you want to use, then click on **Properties**. In the new dialog window, select the desired paper format (A4 or US letter). Close the properties dialog when finished.
- Back in the Acrobat Print window, adjust the following settings:
  - Very important: Set Page Sizing to "Actual size", or set Page Scaling to "None" (older Acrobat versions).**
  - Select "Auto portrait/landscape" under Orientation.**
- Ensure you have enough sheets of paper available.
- Click on **OK**. Your printer will output a series of sheets which you can re-assemble. Each sheet is numbered by row and column in its upper left corner – for example, this sheet is (1, 1). Line up the edge-marks to form a 1:1 pattern of the anchor.

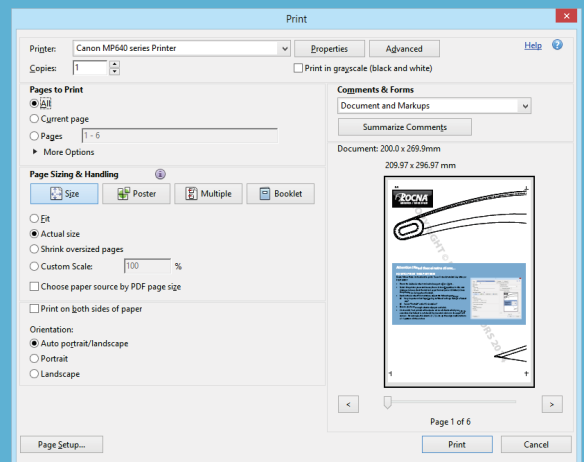

(2, 1)

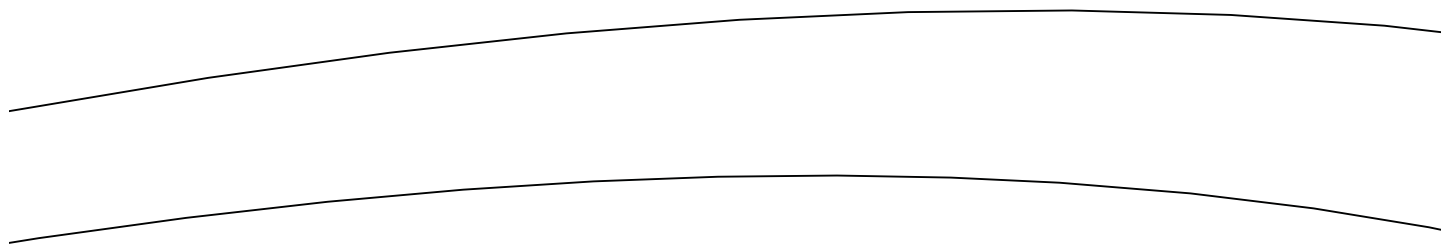
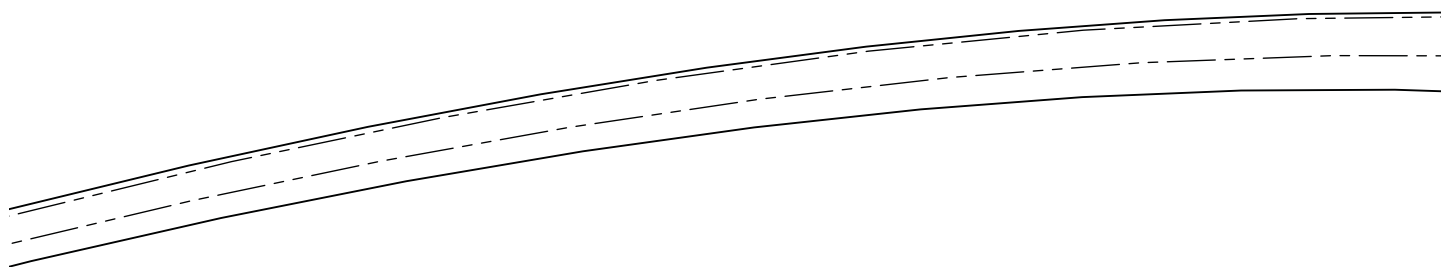

+

+

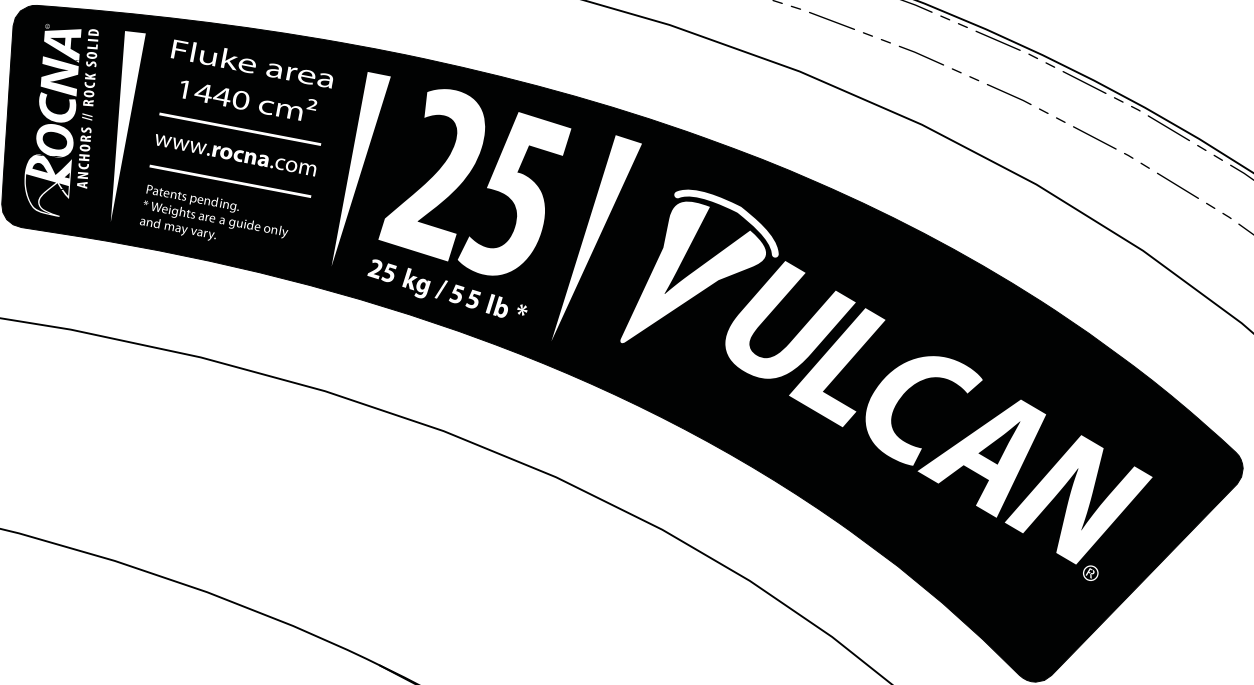

**ROCNA**  
ANCHORS // ROCK SOLID

Fluke area  
1440 cm<sup>2</sup>

[www.rocna.com](http://www.rocna.com)

Patents pending.  
\* Weights are a guide only  
and may vary.

**25**  
25 kg / 55 lb \*

**VULCAN**®

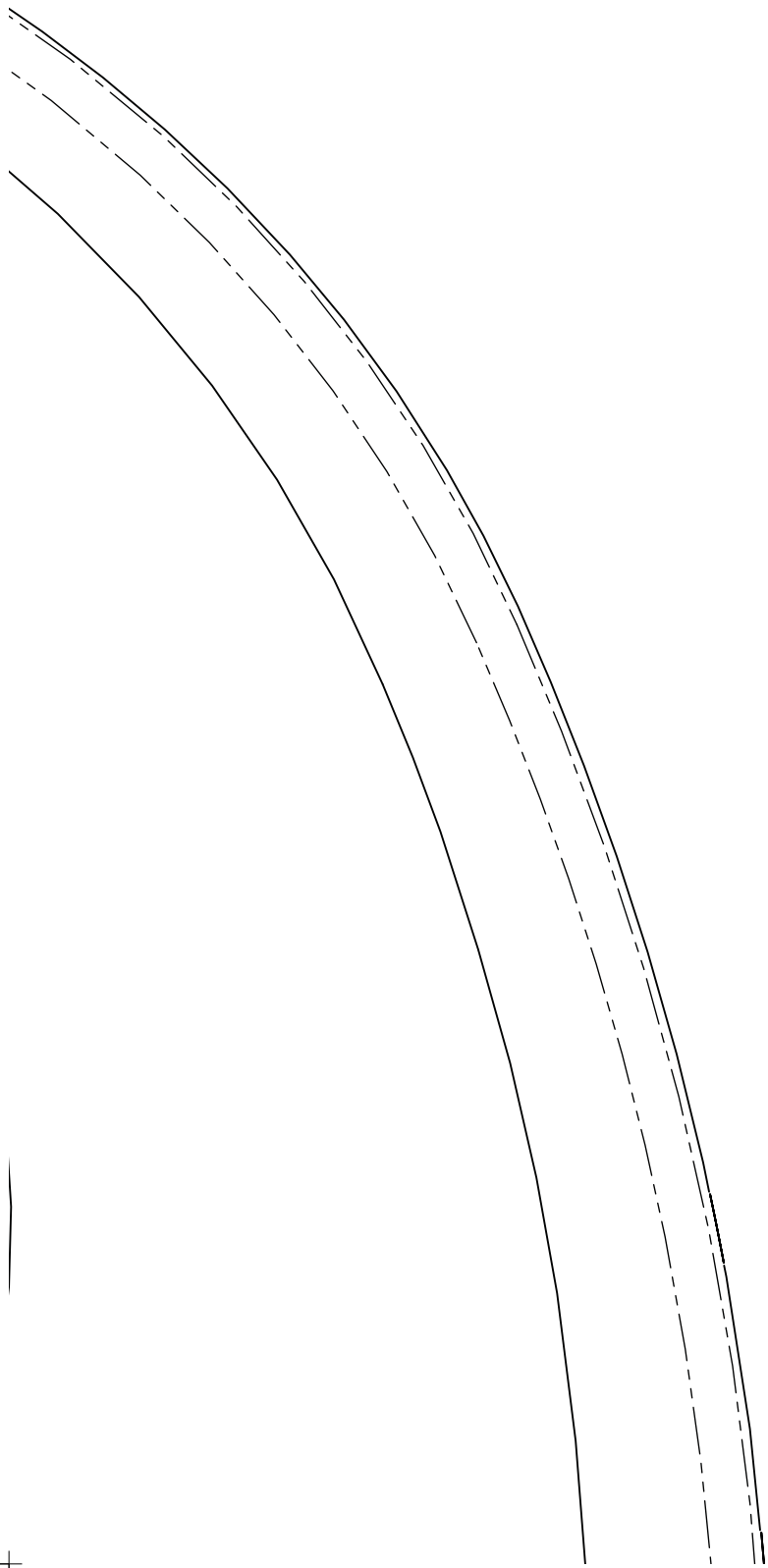

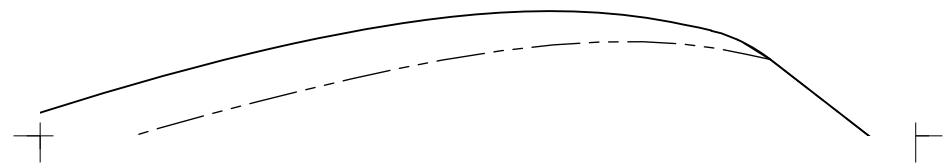

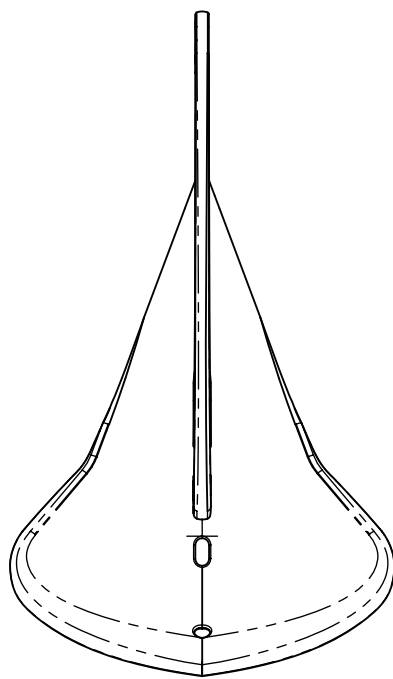

Width: 476 mm (18.7 inches)

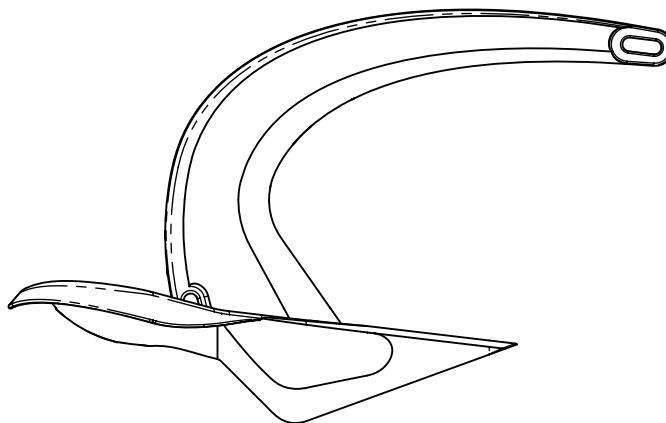
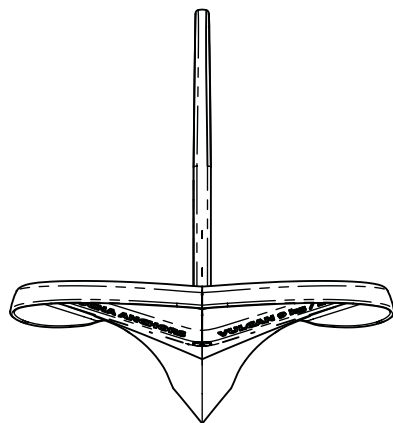

**DISCLAIMER**

The descriptions and guidelines shown in this literature should be used as a general reference only. For any further technical information please contact our Technical Service. The contents of this guide are based on the latest information available at the time of publication.

CMP / Rocna Anchors assumes no responsibility for the accuracy of the information contained herein. Product specifications are subject to change without notice.

**PATENTS & DESIGN PROTECTION**

Rocna and Vulcan anchors enjoy patent and design protection in numerous jurisdictions. Additional patents pending.

**TRADEMARKS & COPYRIGHT**

The names "Rocna" and "Vulcan" are registered trademarks<sup>®</sup> and the Rocna, "Kiwi-R", and Vulcan logos are trademarks<sup>™</sup> of Rocna Anchors. All distributable media, including video, graphics, photography, and all copy printed or electronic is copyright © 2004–2014 Rocna Anchors. All rights reserved.

This document is supplied to you for the explicit and sole purpose of evaluating the possible fit of a Vulcan anchor on a vessel. Any other utilization of this document, whether for personal use or other, may constitute a violation of the copyright laws of your state in addition to any applicable patent and/or design protection.

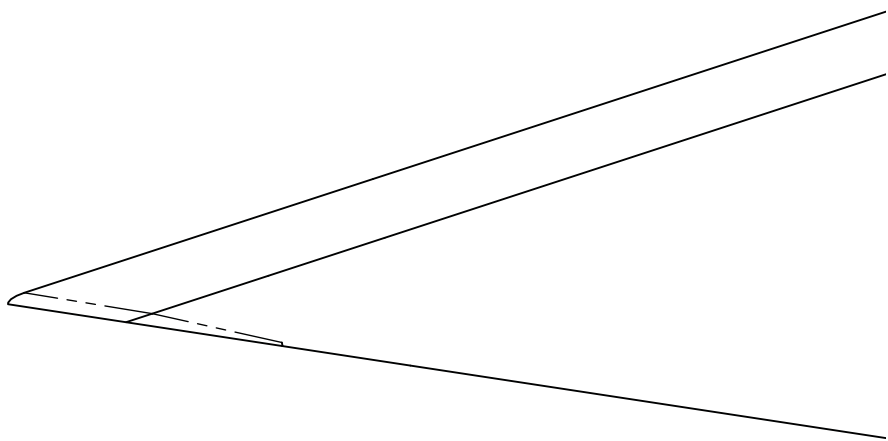

(3, 2)

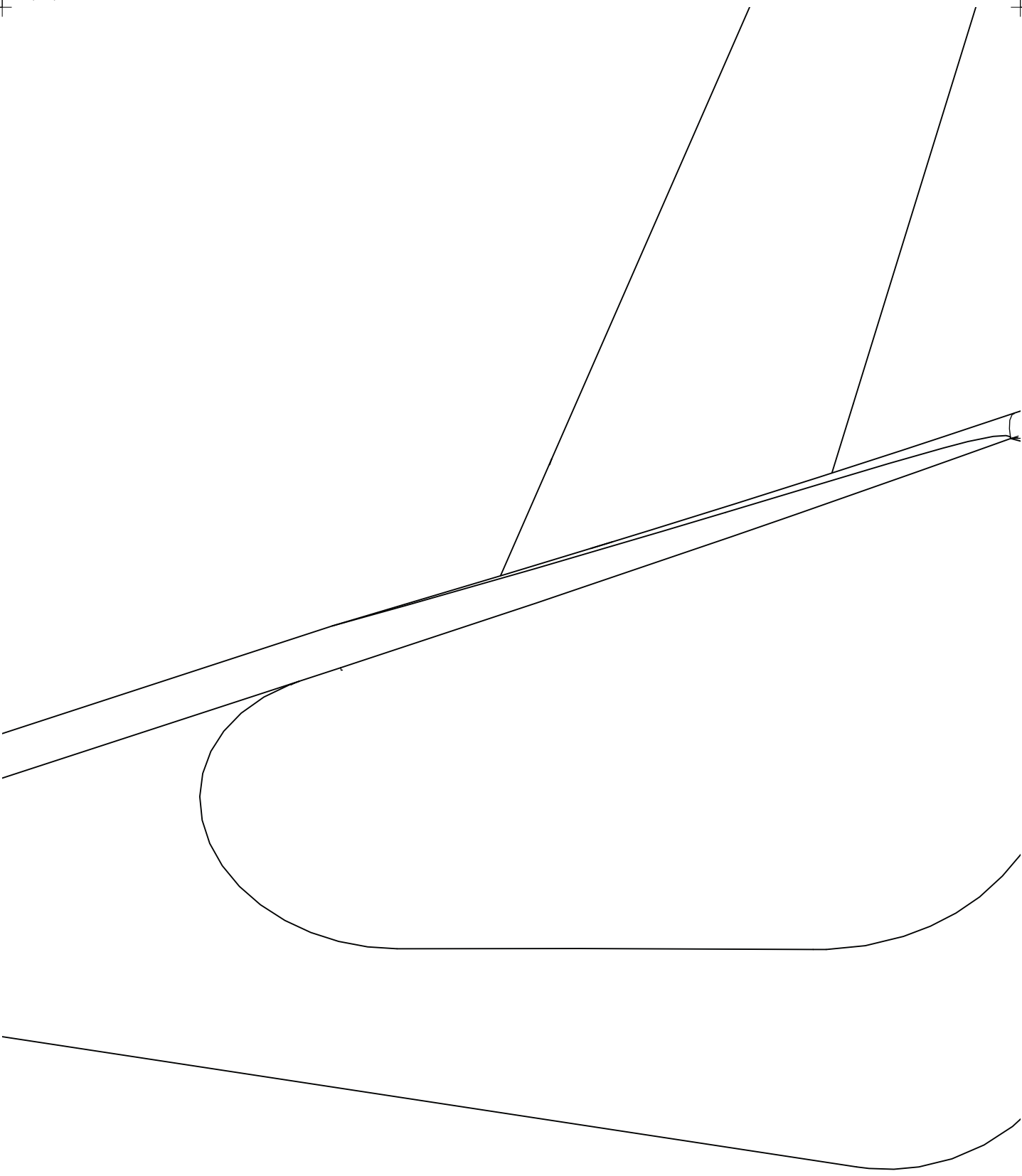

T

T



(4, 2)

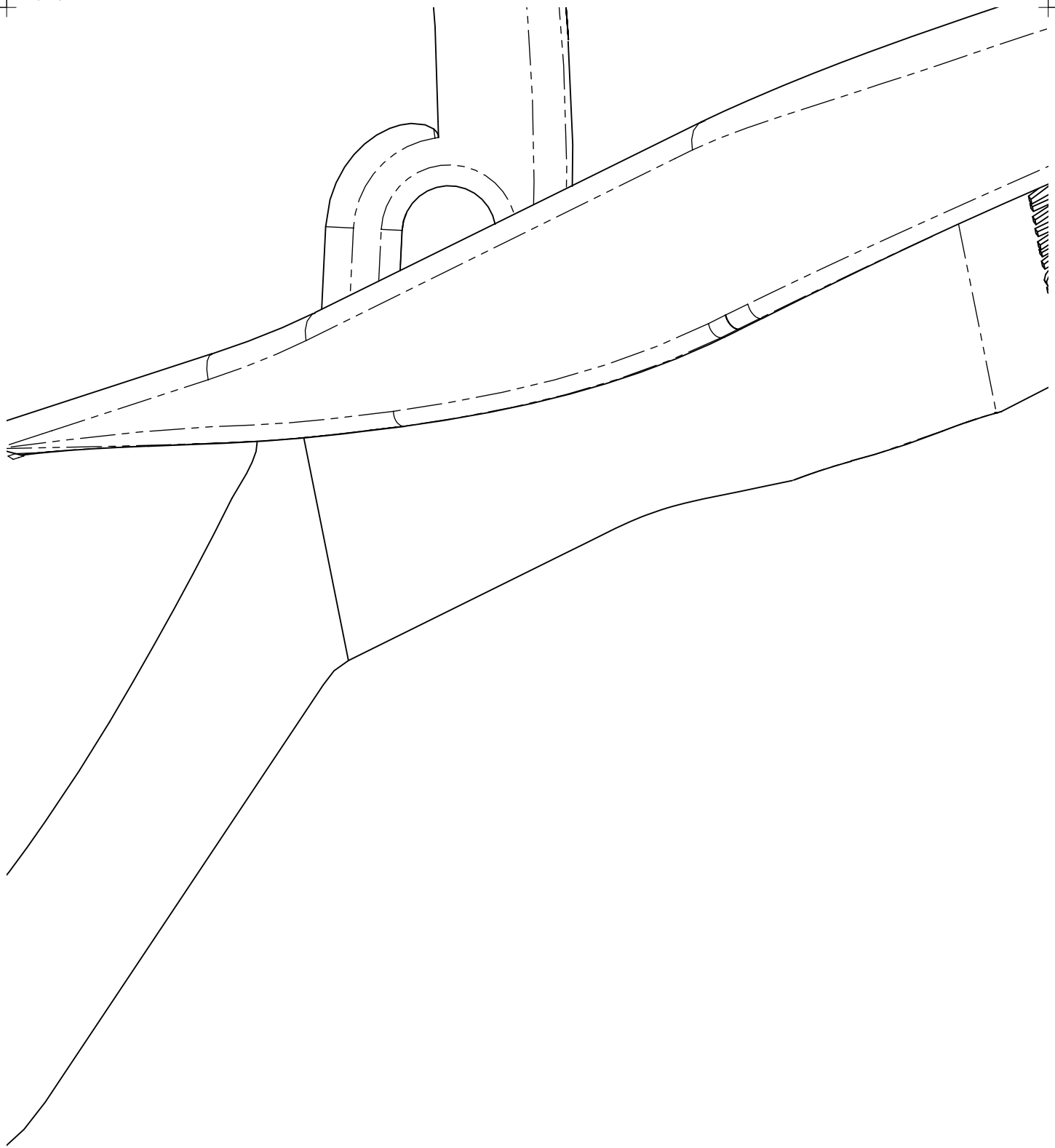

T

T

(5, 2)

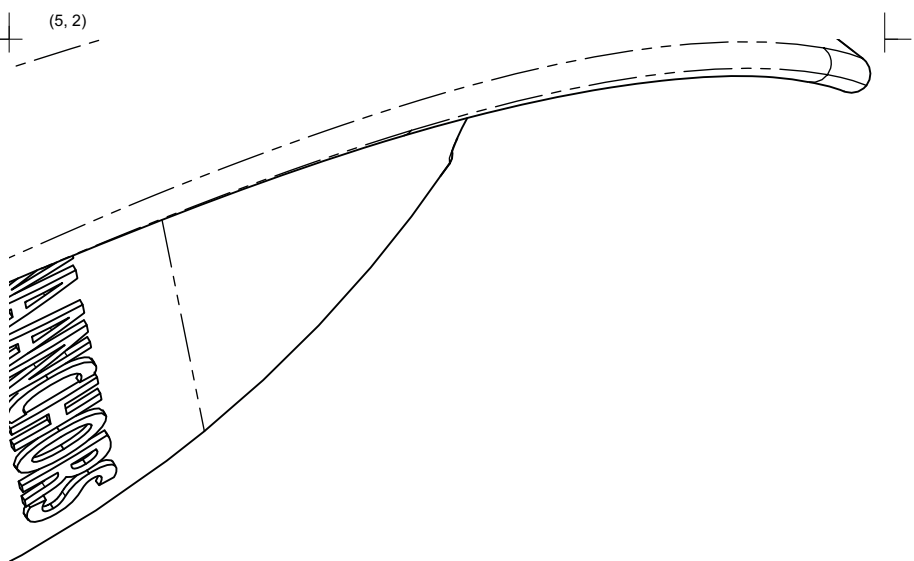

T