



Attention! Read these instructions...

HOW TO PRINT THIS PATTERN

Please follow these instructions to print. You will need A4 or letter size paper:

- ▶ From the Adobe Acrobat main window, go to **File > Print...**
- ▶ Select the printer you want to use, then click on **Properties**. In the new dialog window, check the paper format (A4 or US letter) is correct. Close the properties dialog when finished.
- ▶ In the Acrobat Print window, adjust the following settings:
 - Very important: Under **Page Sizing**, select **Size**, and then **“Actual size”**,
 - or set **Page scaling** to **“None”** or **“100%”** (old Acrobat versions).
- ▶ Select **“Auto”** under **Orientation**.
- ▶ Ensure you have enough sheets of paper available.
- ▶ Click on **Print**. Your printer will output a series of sheets which you can reassemble. Each sheet is numbered by (row, column) in its upper left corner. Line up the edge-marks to form a 1:1 pattern of the anchor side profile.

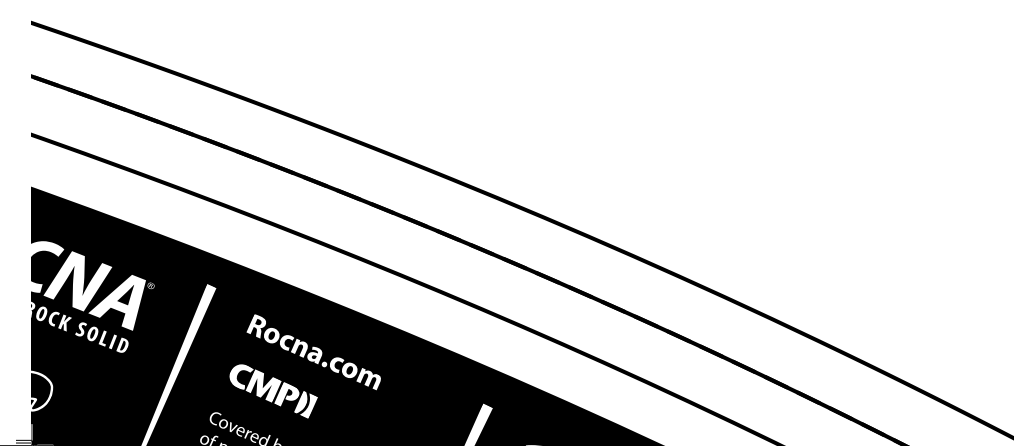
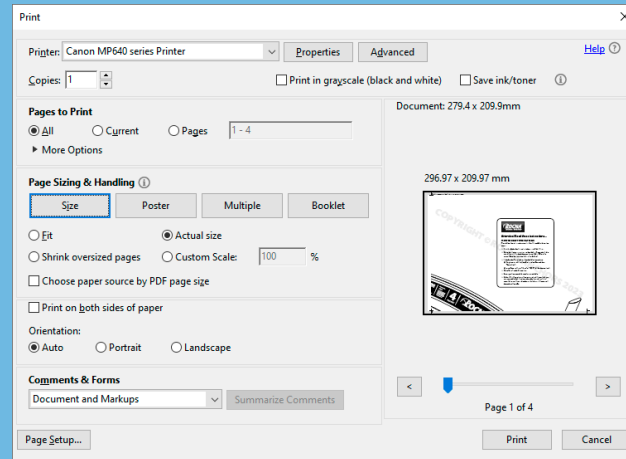

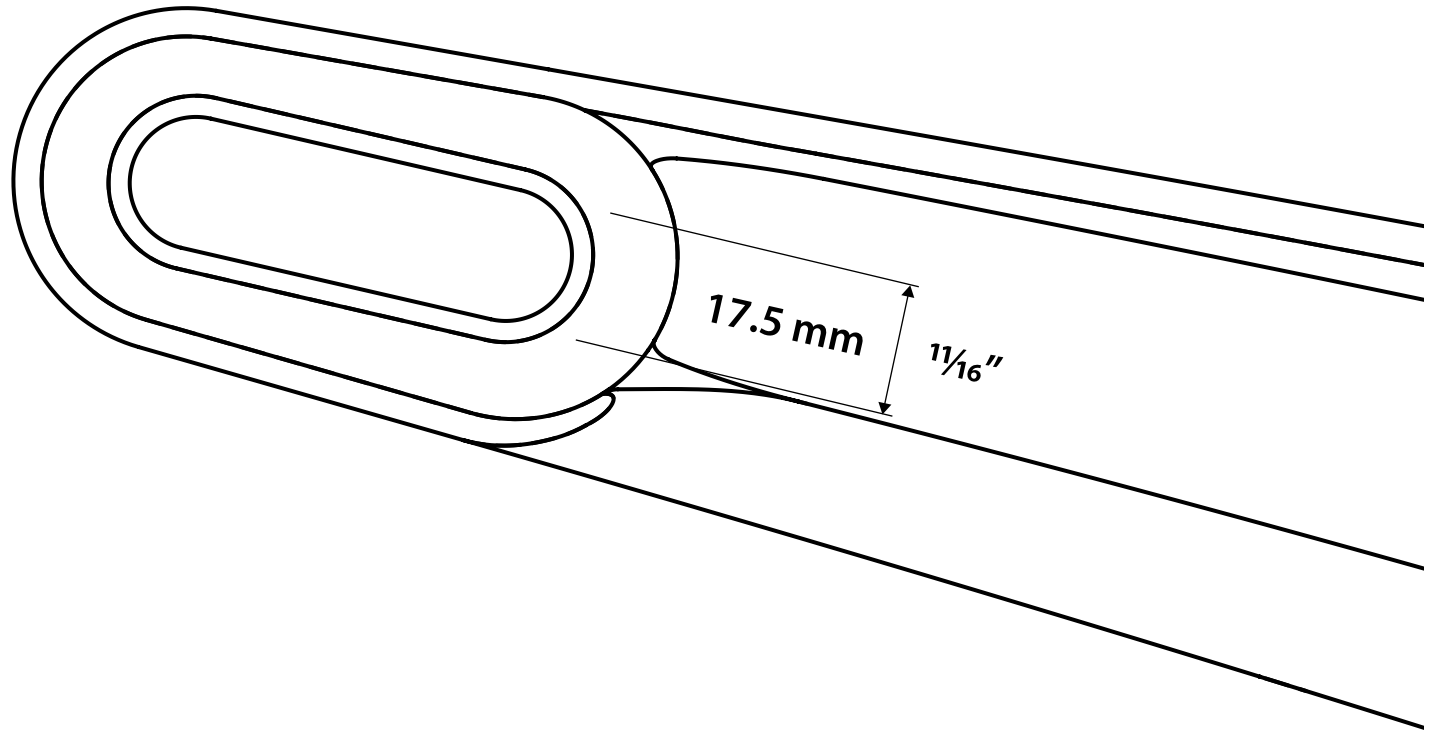

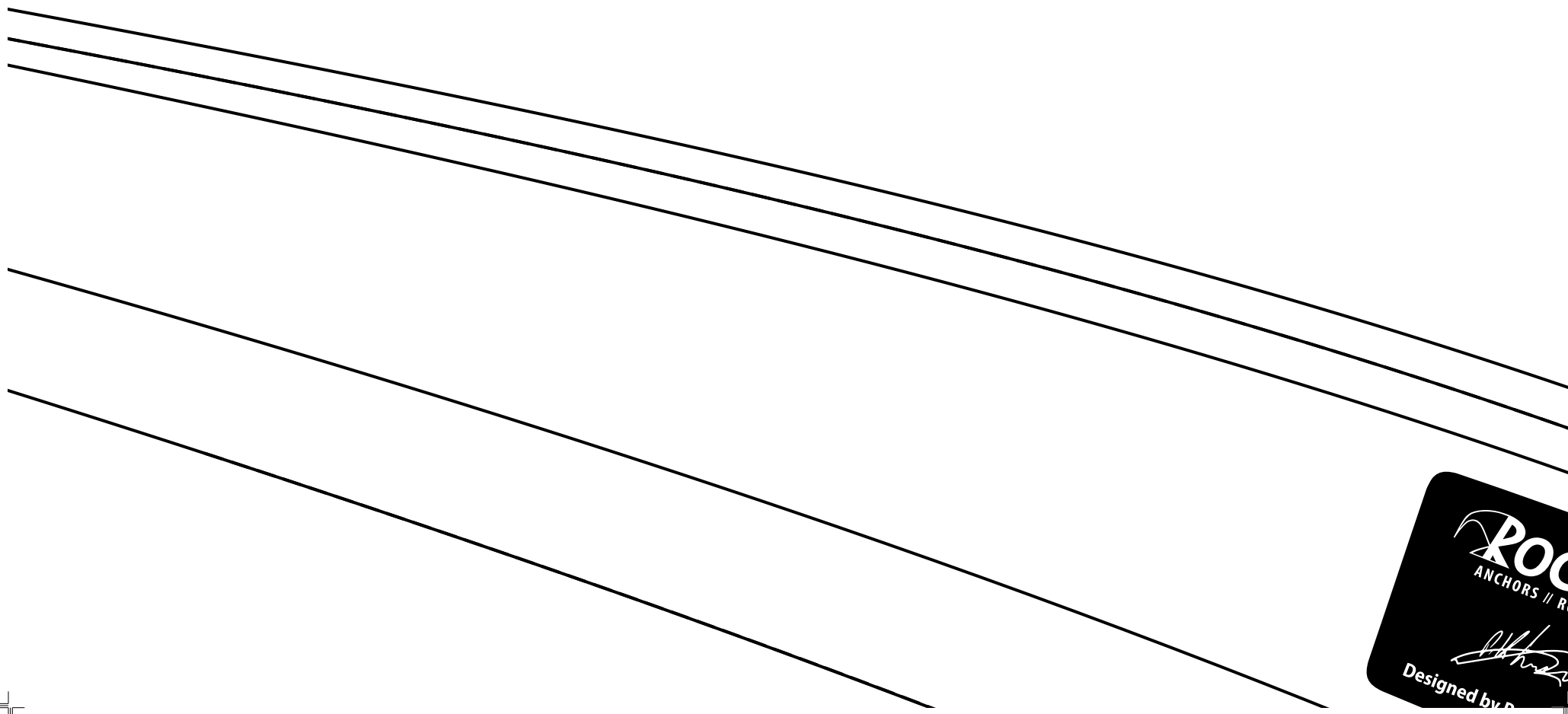

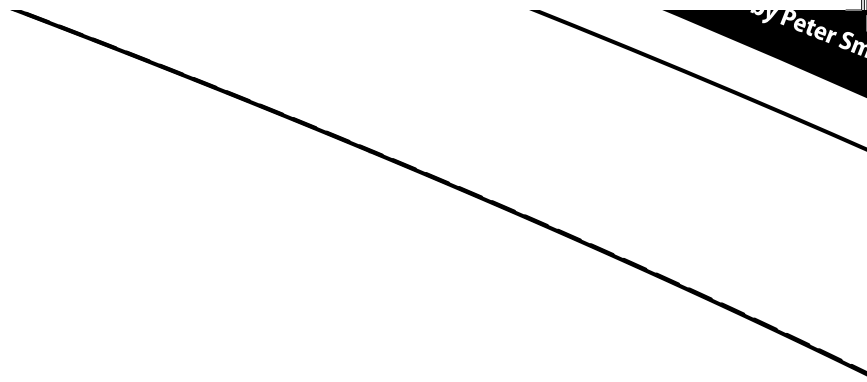

with

protected by one or more
patents: US8950352,
NZ602454, NZ620976,
CA2790598, CA2922499,
GB2505931, GB2518531
*Weights may vary.

25

25 kg / 55 lb *

ROCNA[®]
MK II

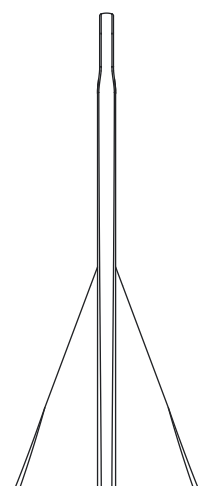
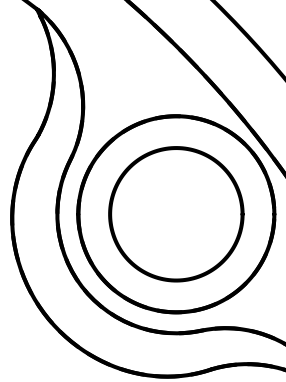

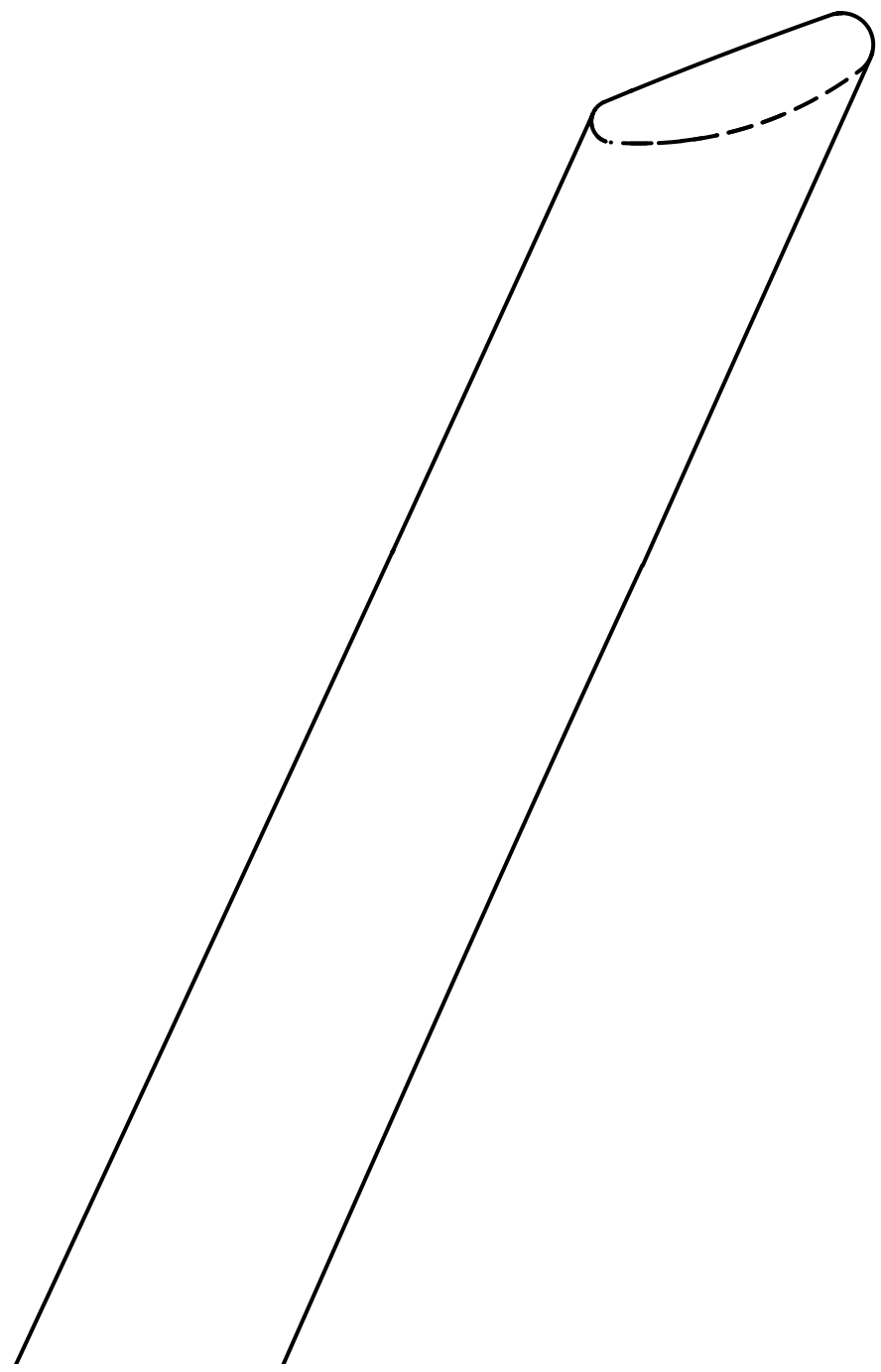
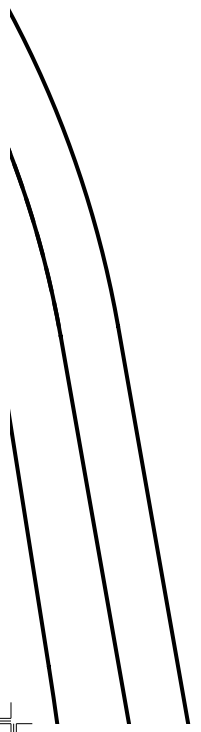

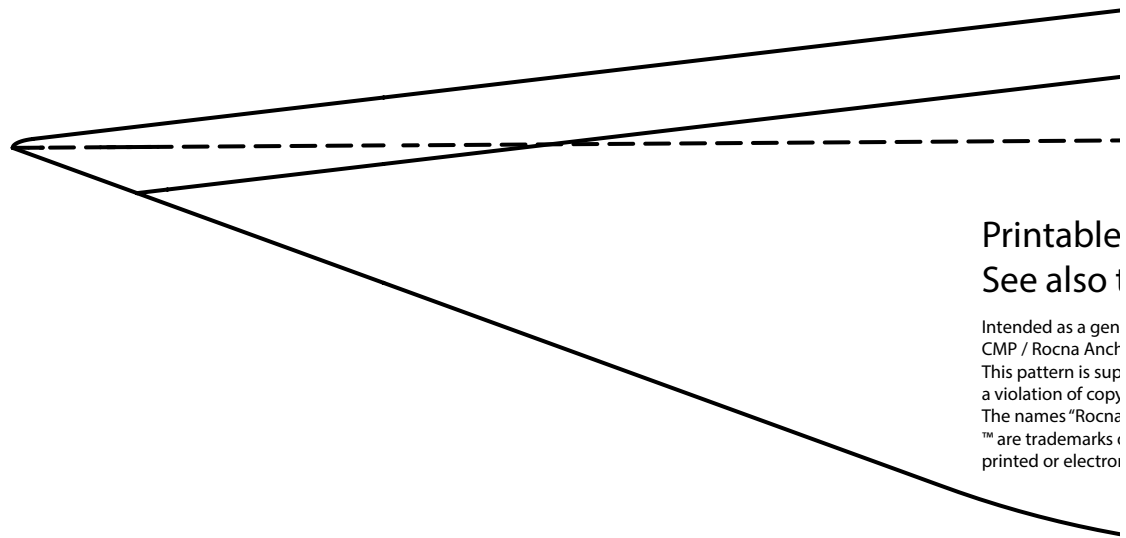

Printable
See also 1

Intended as a gen
CMP / Rocna Anch
This pattern is sup
a violation of copy
The names "Rocna
™ are trademarks c
printed or electri

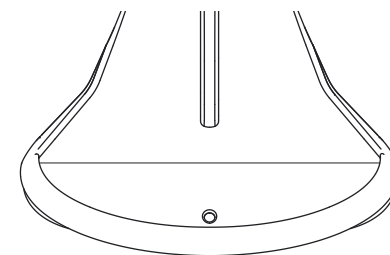

TOP VIEW

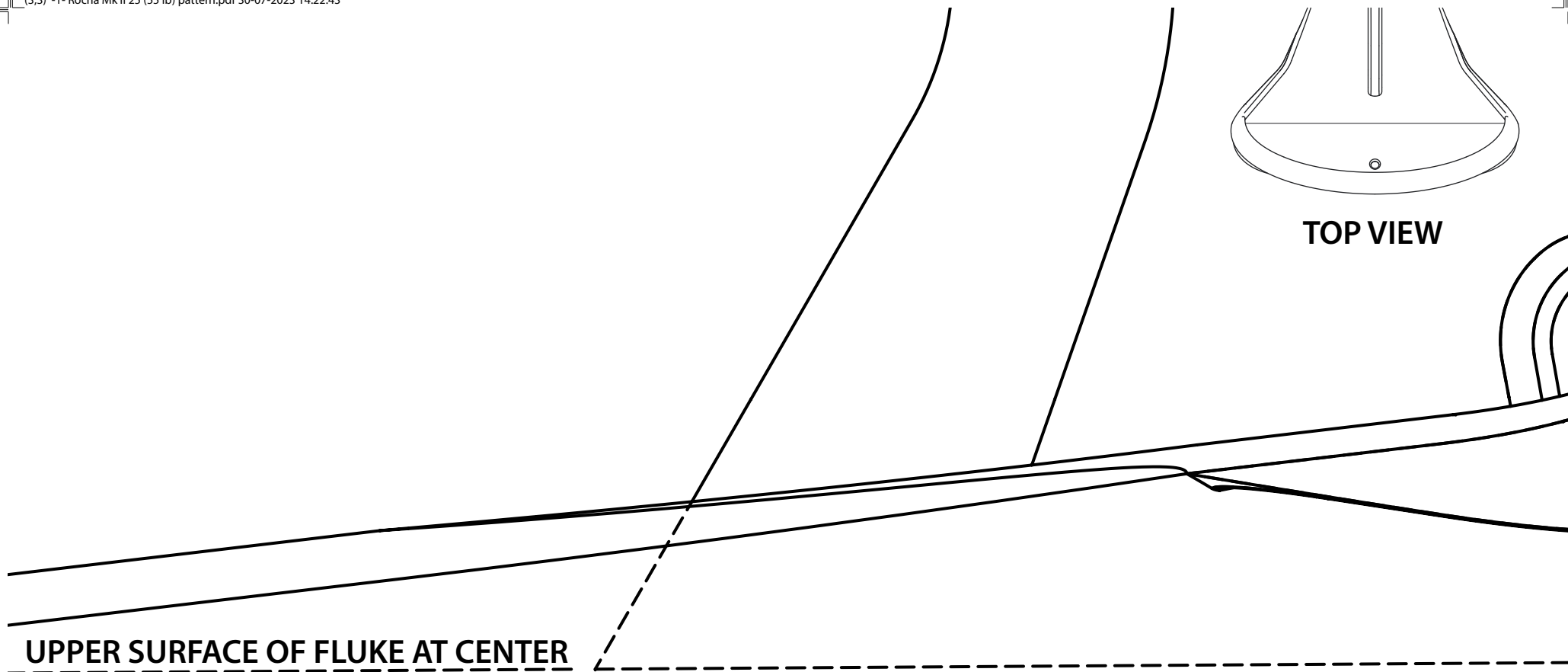

UPPER SURFACE OF FLUKE AT CENTER

Patterns and assemblable patterns, sizing guidelines, and more resources are available at **Rocna.com**.
Visit the Rocna Knowledge Base at **kb.rocna.com**. For further assistance e-mail **support@rocna.com**.

This drawing is for general reference only. May not be an exact or complete representation of the product. Dimensions may vary. Contents based on the latest information available at the time of publication.
Rocna Anchors assumes no responsibility for the accuracy of the information contained herein. Product specifications are subject to change without notice.
This document is provided to you for the explicit and sole purpose of evaluating the possible fit of a Rocna anchor on a vessel. Any other use of this document may constitute a copyright, patent, design, or other law. The Rocna Mk II anchor is patented as described on the label above.
"Rocna", "Kiwi-R" and "Vulcan" are registered trademarks ® and the Rocna, "Kiwi-R", and Vulcan logos, and other terms marked with ® are trademarks of Rocna Anchors. All distributable media, including video, graphics, photography, and all copy rights are copyright © 2004–2023 Rocna Anchors. All rights reserved.

MAXIMUM WIDTH HERE
499 mm / 19 5/8"

UPPER SURFACE OF FLUKE AT CENTER

