



Attention! Read these instructions...

HOW TO PRINT THIS PATTERN

Please follow these instructions to print. You will need A4 or letter size paper:

- ▶ From the Adobe Acrobat main window, go to **File > Print...**
- ▶ Select the printer you want to use, then click on **Properties**. In the new dialog window, check the paper format (A4 or US letter) is correct. Close the properties dialog when finished.
- ▶ In the Acrobat Print window, adjust the following settings:
 - Very important: Under **Page Sizing**, select **Size**, and then **"Actual size"**,
 - or set **Page scaling** to **"None"** or **"100%"** (old Acrobat versions).
- ▶ Select **"Auto"** under **Orientation**.
- ▶ Ensure you have enough sheets of paper available.
- ▶ Click on **Print**. Your printer will output a series of sheets which you can reassemble. Each sheet is numbered by (row, column) in its upper left corner. Line up the edge-marks to form a 1:1 pattern of the anchor side profile.

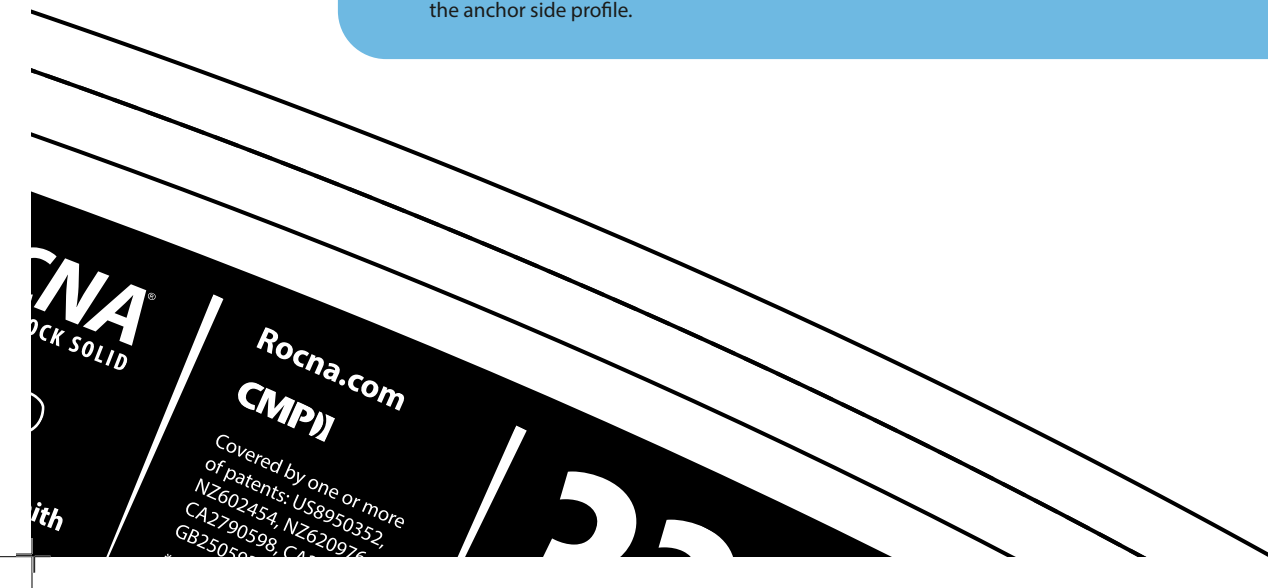
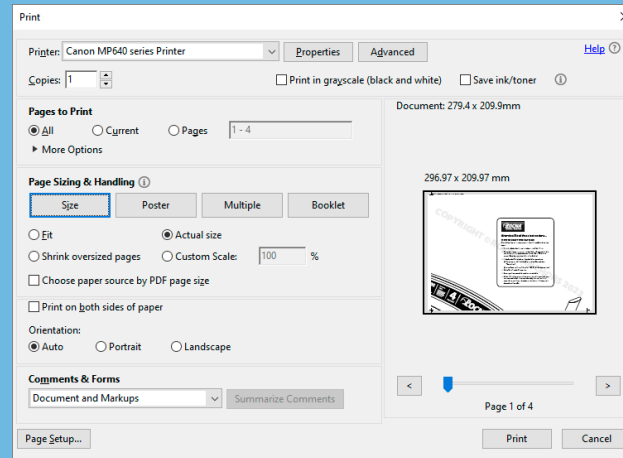

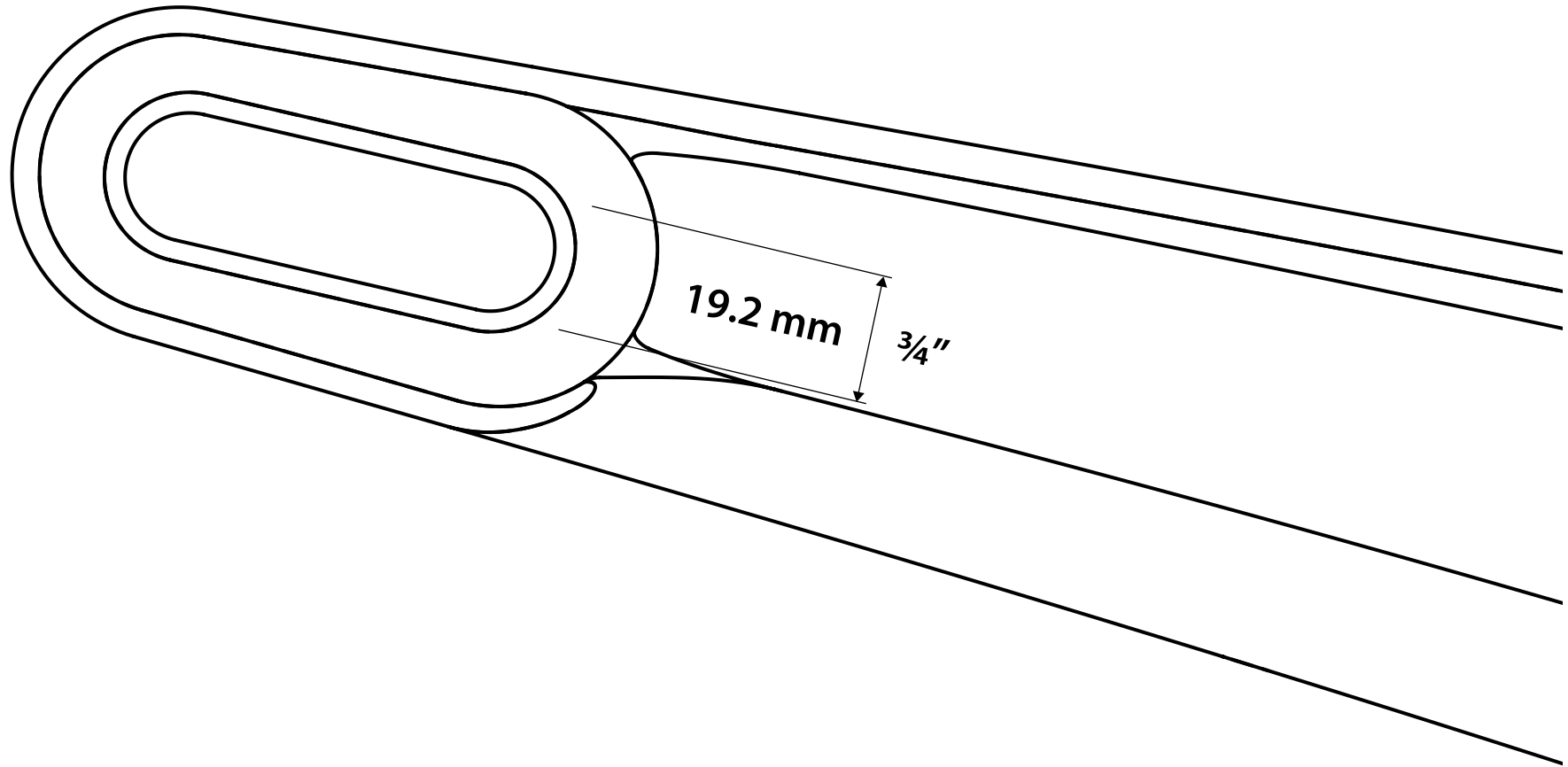

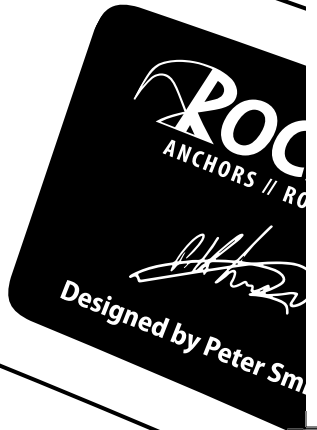
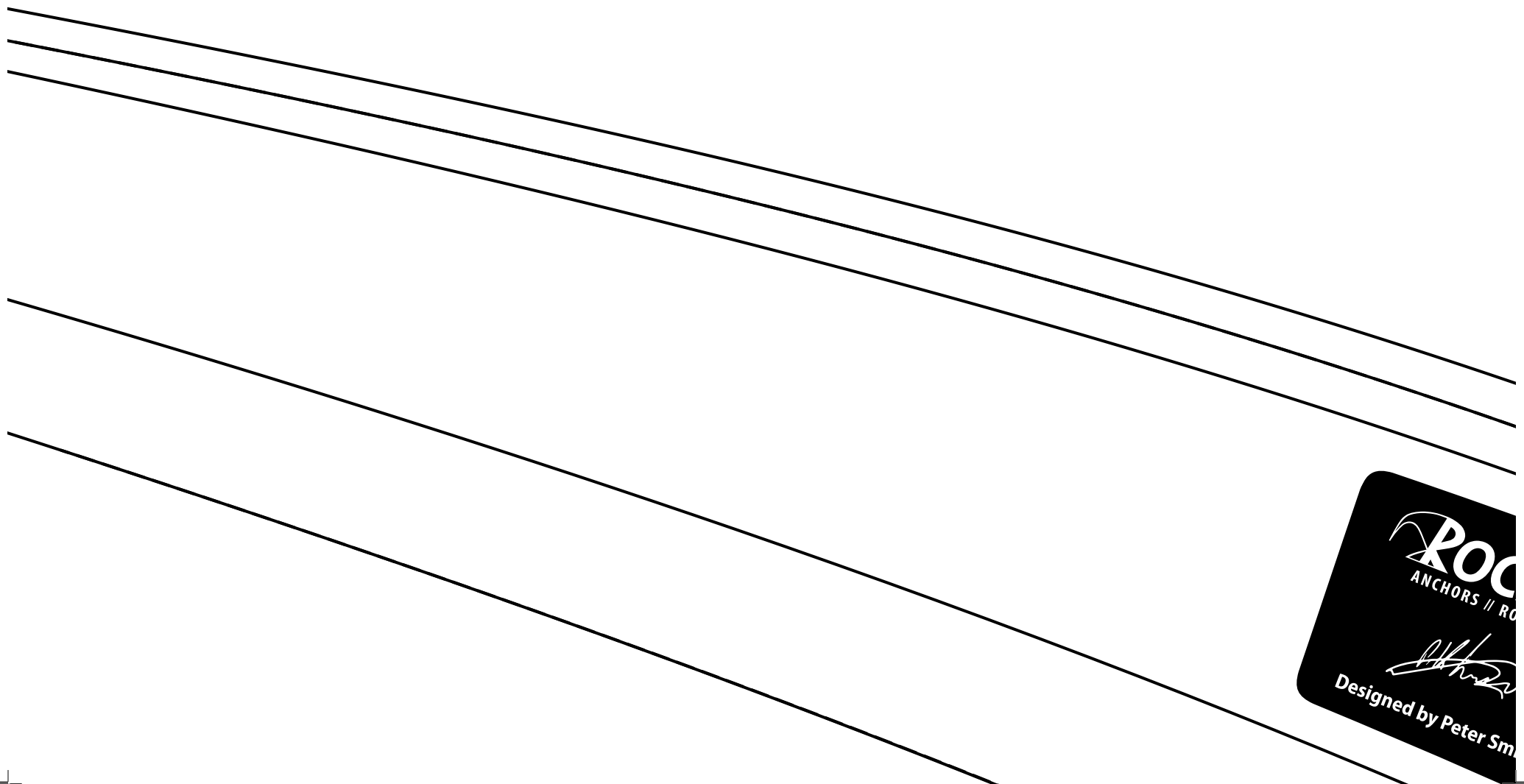

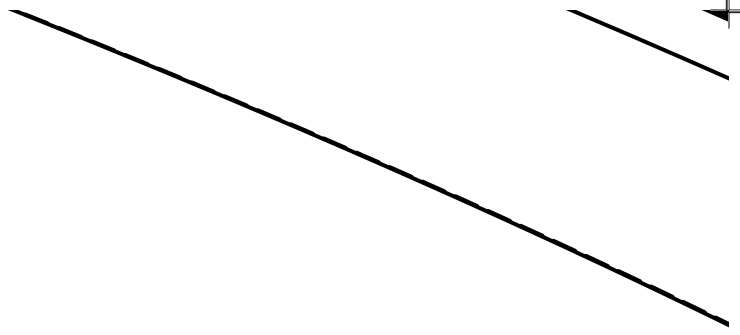

CA2922499,
35931, GB2518531
*Weights may vary.

33

33 kg / 73 lb *

ROCNA[®]
MK II

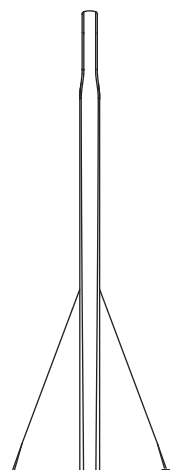
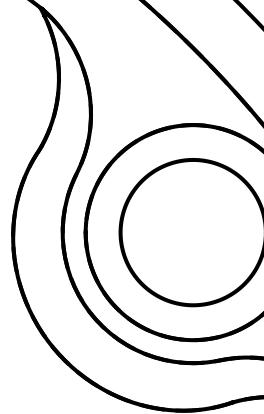

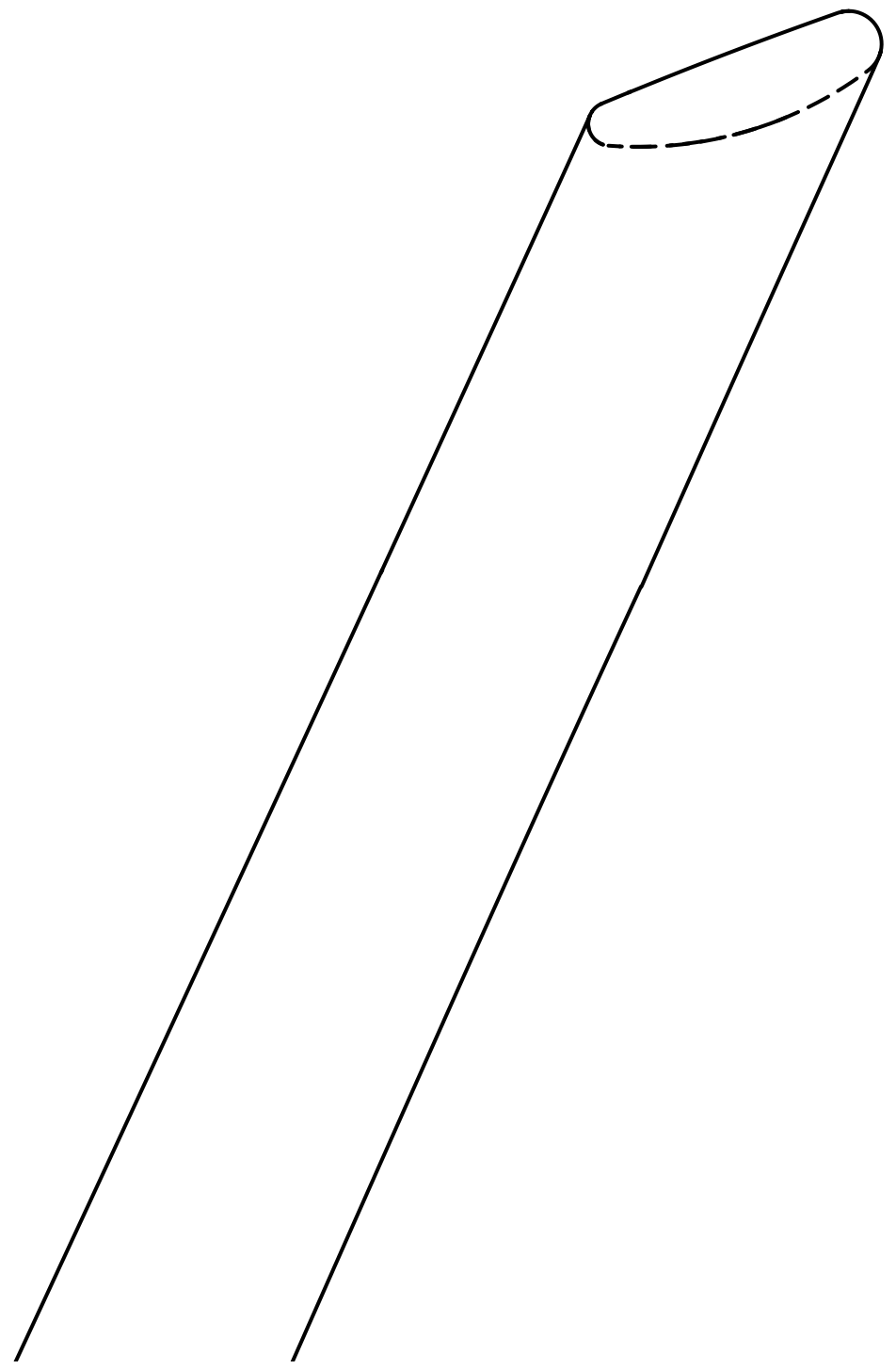
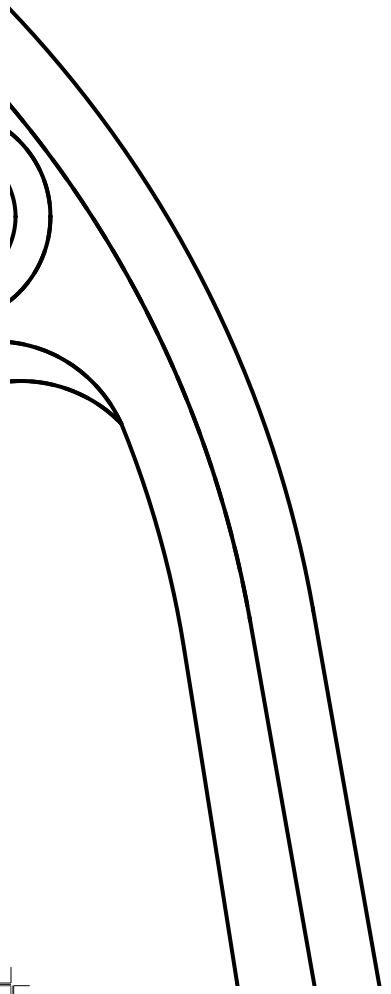

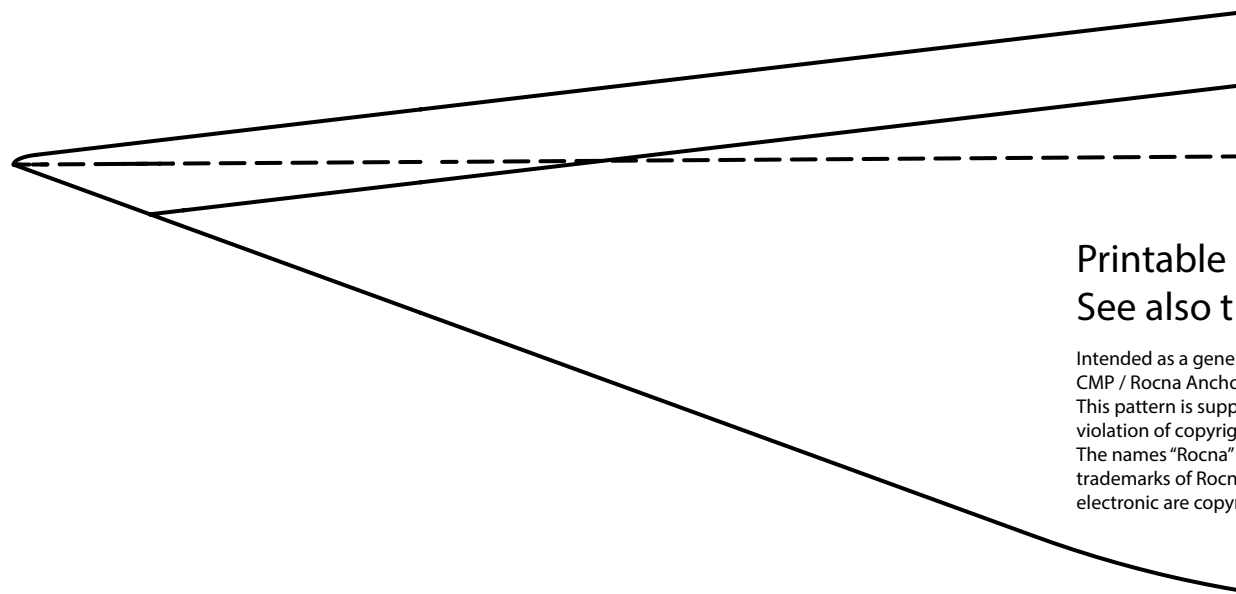

Printable
See also t

Intended as a gene
CMP / Rocna Anchr
This pattern is supp
violation of copyrig
The names "Rocna"
trademarks of Rocn
electronic are copy

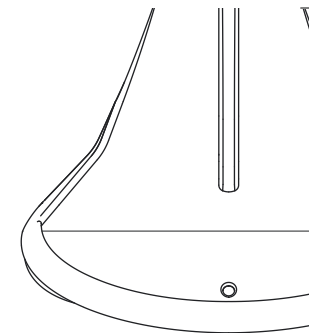

TOP VIEW

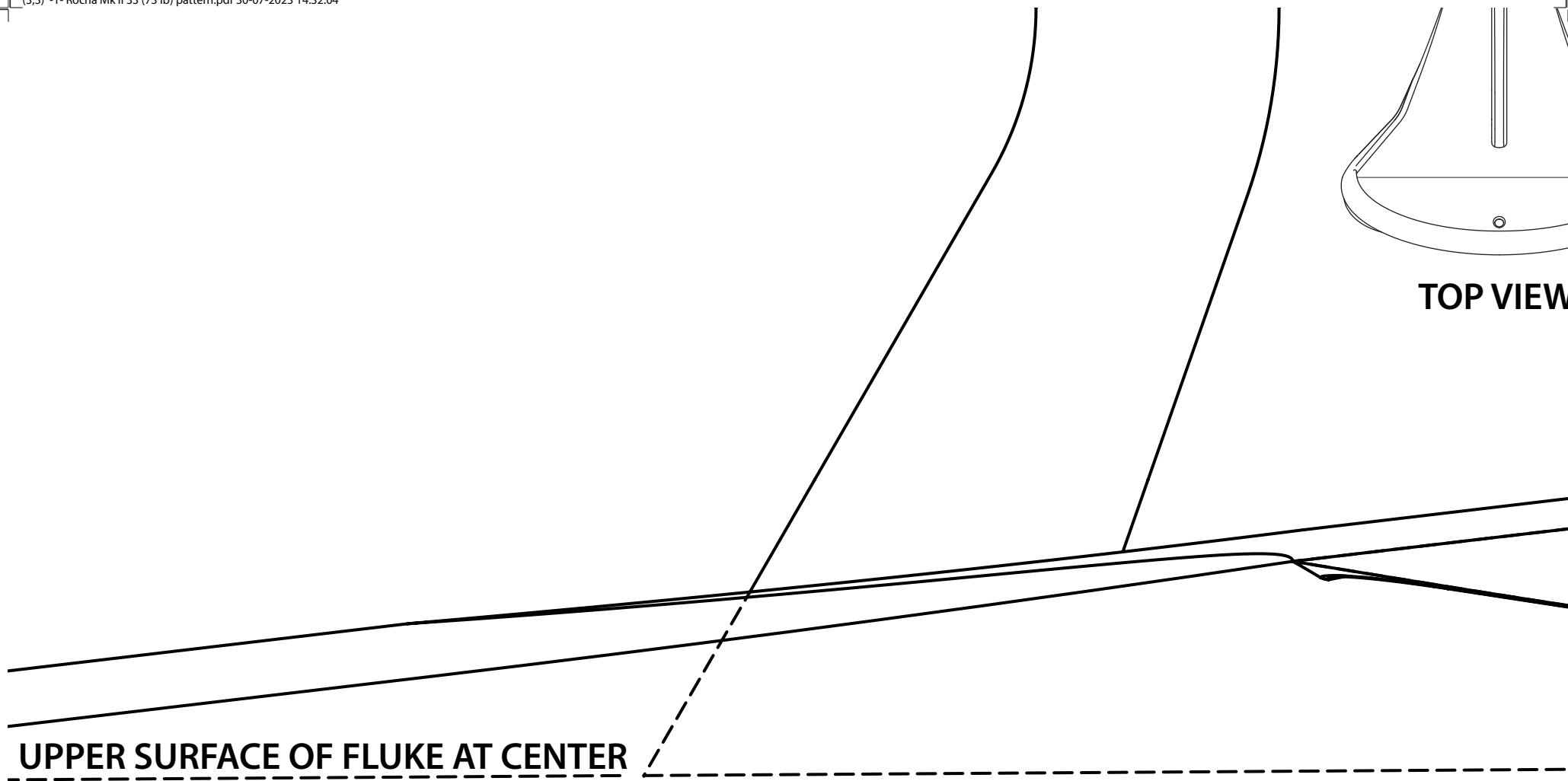

UPPER SURFACE OF FLUKE AT CENTER

and assemblable patterns, sizing guidelines, and more resources are available at **Rocna.com**.
The Rocna Knowledge Base at **kb.rocna.com**. For further assistance e-mail **support@rocna.com**.

For reference only. May not be an exact or complete representation of the product. Dimensions may vary. Contents based on the latest information available at the time of publication.
Rocna assumes no responsibility for the accuracy of the information contained herein. Product specifications are subject to change without notice.
This document is provided to you for the explicit and sole purpose of evaluating the possible fit of a Rocna anchor on a vessel. Any other use of this document may constitute a violation of copyright, patent, design, or other law. The Rocna Mk II anchor is patented as described on the label above.
"Rocna" and "Vulcan" are registered trademarks ® and the Rocna, "Kiwi-R", and Vulcan logos, and other terms marked with ™ are trademarks of Rocna Anchors. All distributable media, including video, graphics, photography, and all copy printed or otherwise reproduced are the property of Rocna Anchors. All rights reserved. © 2004–2023 Rocna Anchors. All rights reserved.

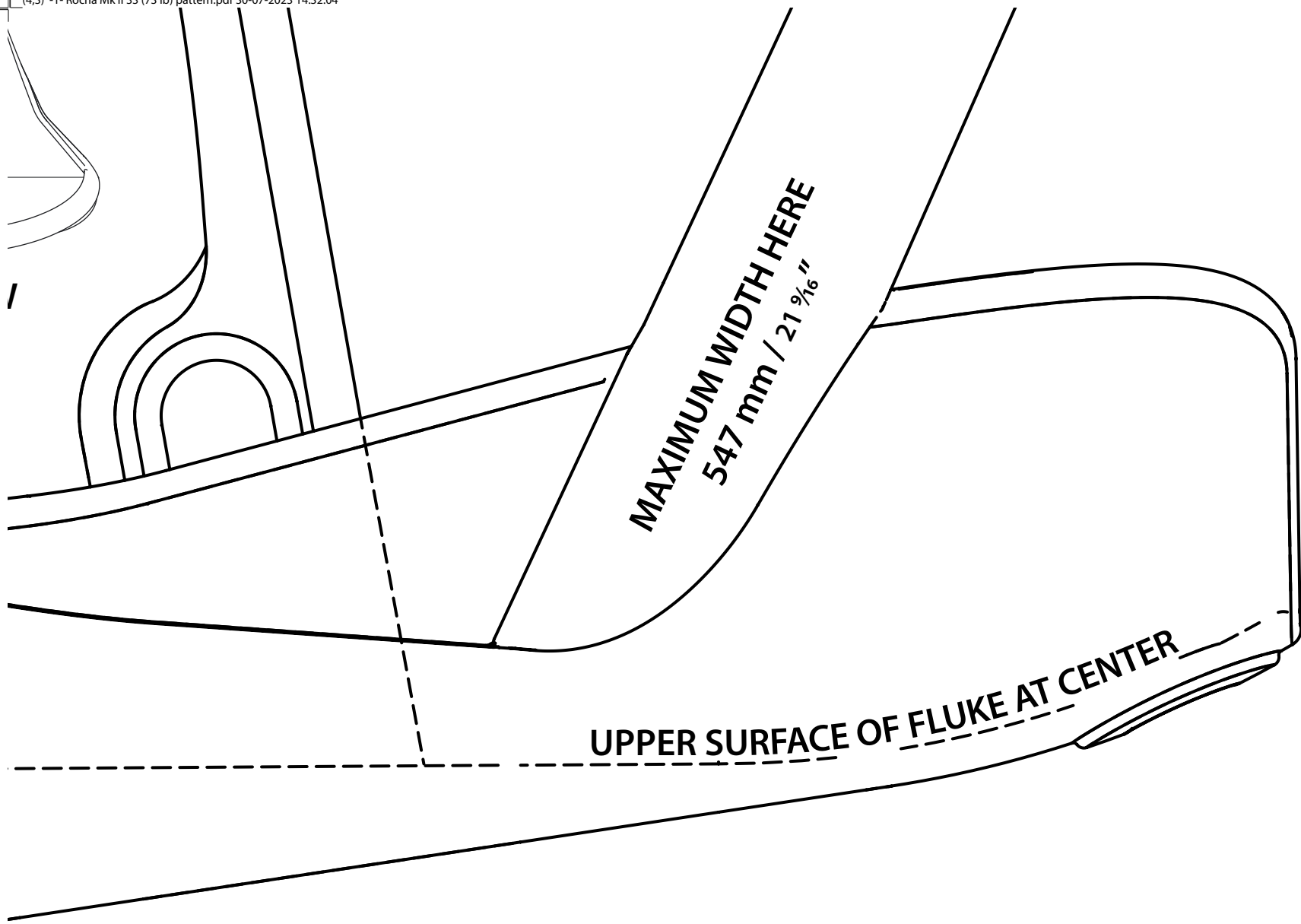

MAXIMUM WIDTH HERE
547 mm / 21 ⁹/₁₆''

UPPER SURFACE OF FLUKE AT CENTER