

attention! read this...

how to print this pattern:

Please follow these instructions to print. You will need standard A4, letter, or larger paper:

- From the Adobe Acrobat main window, go to **File > Print...**
- Select the printer you want to use, then click on **Properties**. In the new dialog window, select the desired paper format. Close the properties dialog when finished.
- Back in the Acrobat Print window, adjust the following settings:
 - Very important:** Set Page Scaling to "None"
 - Select "Auto-Rotate and Center"
- Check the Preview pane and ensure you have enough sheets of paper available.
- Click on OK. Your printer will output a series of sheets which you can re-assemble. Each sheet is numbered by row and column in its upper left corner - for example, this sheet is **(1, 1)**. Line up the edge-marks to form a 1:1 pattern of the anchor.

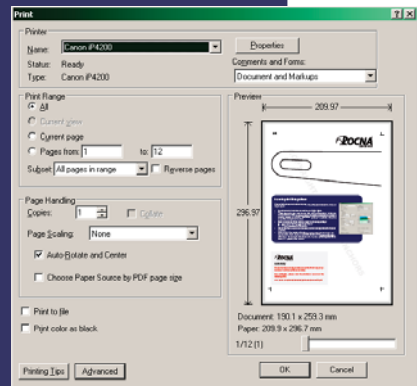

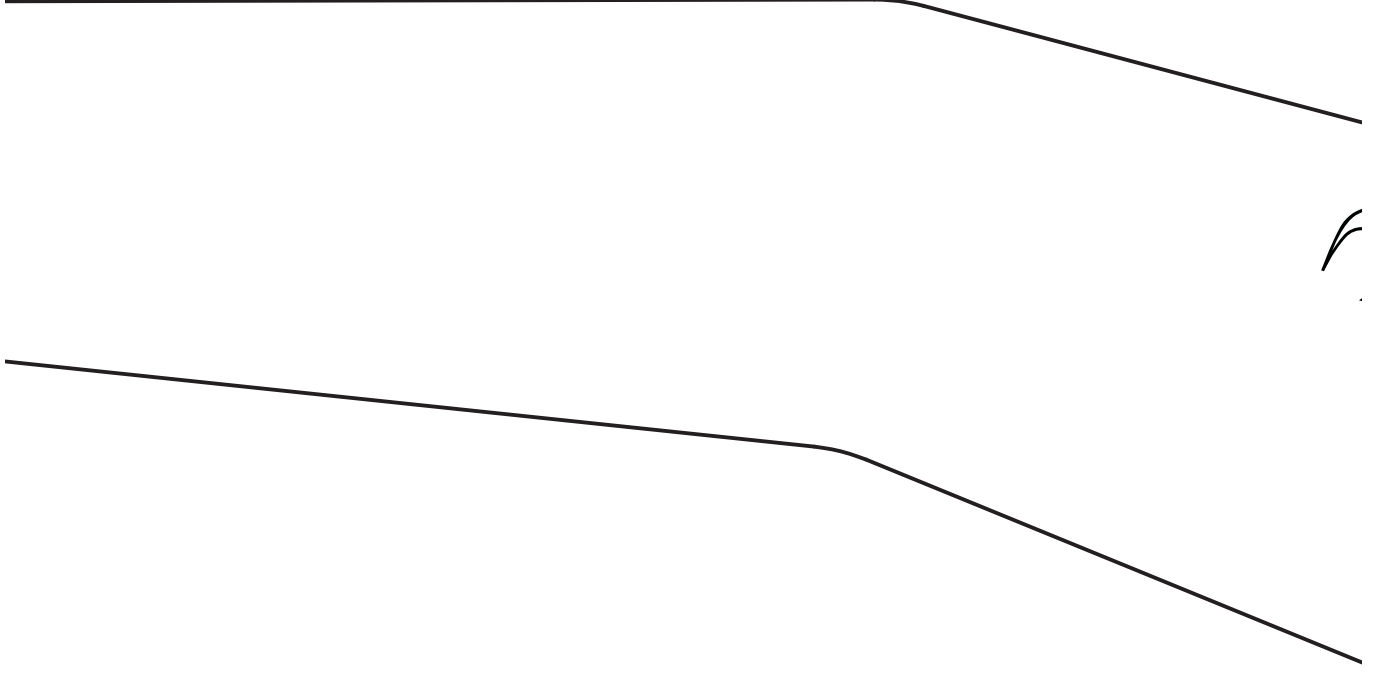

ROCNA[®]
www.rocna.com

6

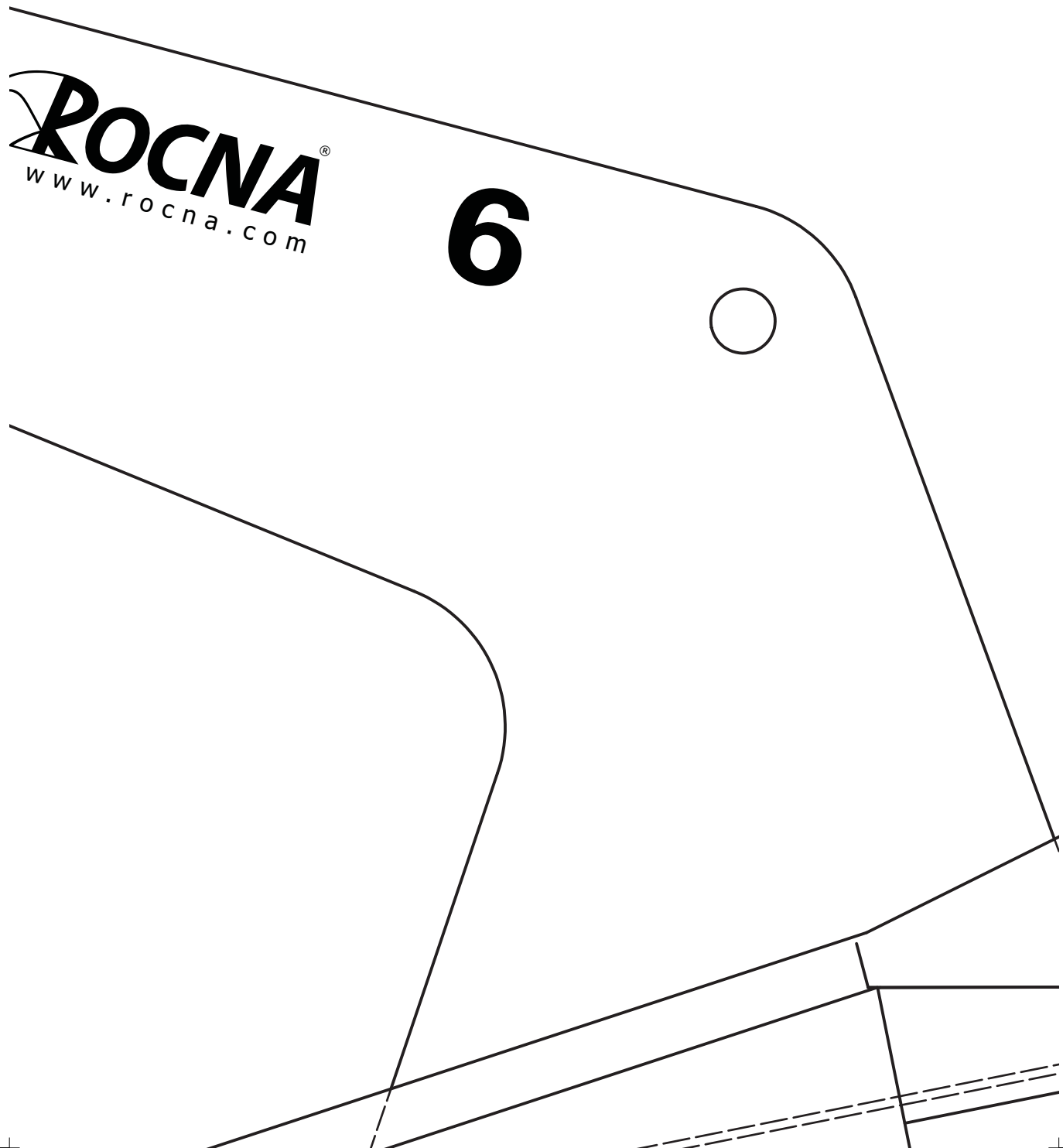

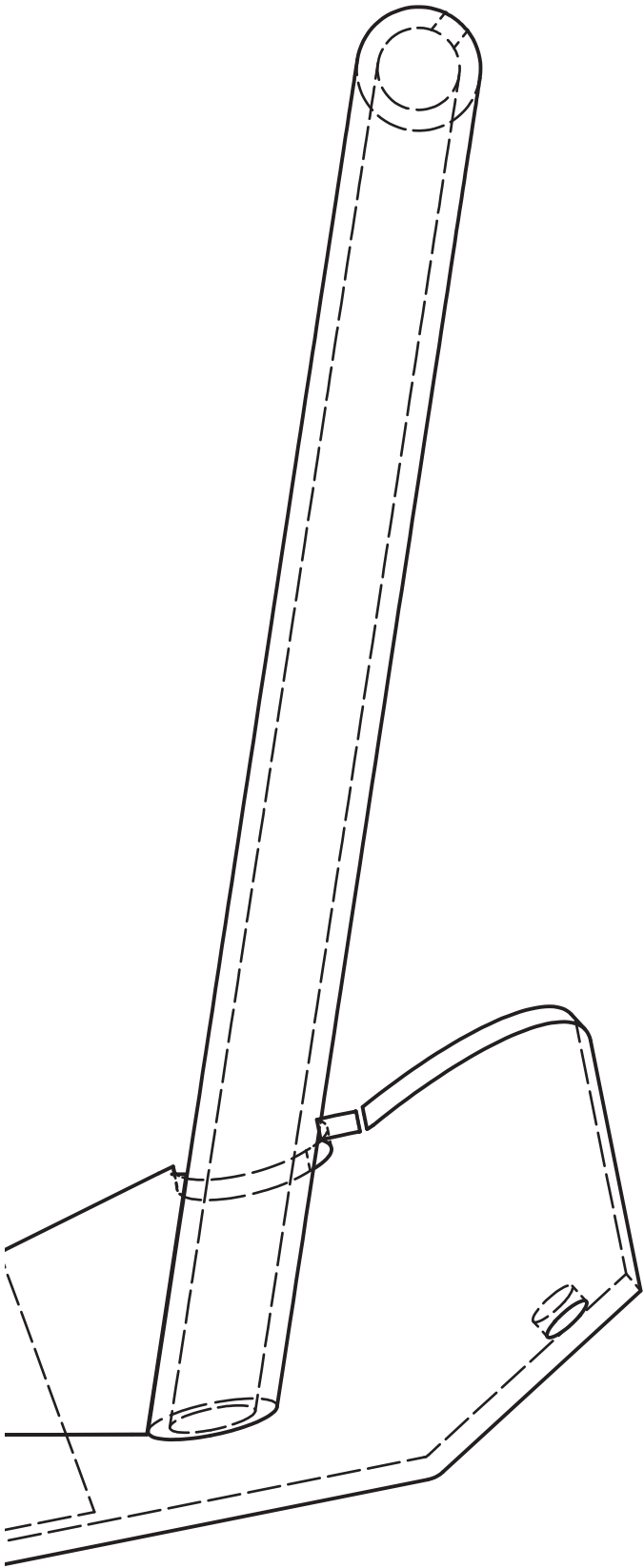

intellectual property protection

Design Registration and Patents

We produce a quality product for a demanding market. A great deal of research and development has been invested in the Rocna anchor, and we are serious about protecting the integrity of our design.

The Rocna is directly protected in most countries. This includes but is not limited to: the USA, Canada, New Zealand, and all 27 member states of the European Union.

If you become aware of a copy, clone, or other imitation anchor which is clearly based on the Rocna design, we would greatly appreciate it being brought to our attention.

DO NOT MAKE ILLEGAL COPIES

Trade Marks and Copyright

The name "Rocna" is a registered trademark ® and the Rocna and "Kiwi-R" logos are trademarks ™ of Rocna Anchors. All distributable media, including video, graphics, photography, and all copy printed or electronic (including this pattern) is copyright © Rocna Anchors. All rights reserved.

Be aware that if you choose to ignore this notice and misuse this document, you will be violating the copyright laws of your state in addition to any patent and/or design protection.

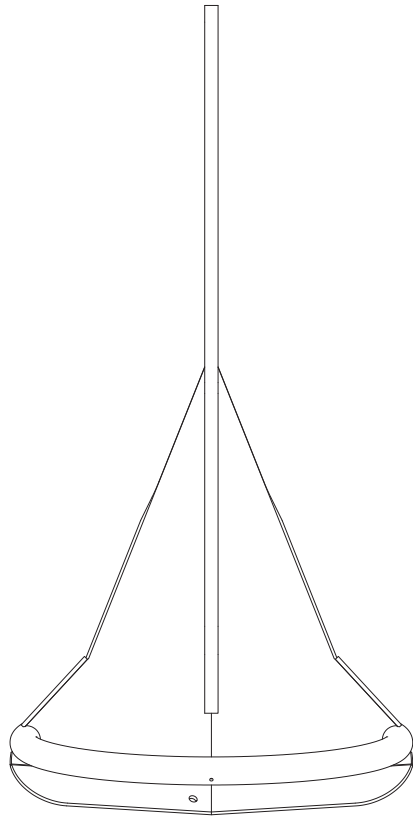

Width: 315mm (12.4 inches)

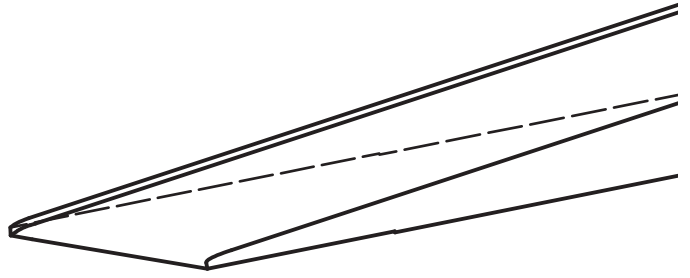
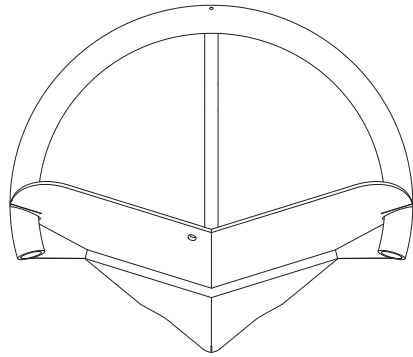

(3, 2)

